

Interns Lightning Talks



PiTiVi

Proxy editing

Anton Belka, antonbelka@gmail.com

GUADEC 2013

What is proxy editing?

Proxy editing is the ability to swap video clips by a "proxy" version that is more suited for editing, and then using the original, full-quality clips to do the render.



Implementation

- GStreamer Editing Services (GES)
 - Design and implement proxy editing API in GES
 - Write tests for proxy editing API
 - Fixing possible issues
- PiTiVi
 - Integrate changes in GES with PiTiVi
 - Fixing possible issues

Summary

- We must have manual/semi-automated and fully-automated modes
- We must be able choose what video clips must use proxy editing mode
- No negative impacts on performance when generating the clips "proxies"

Resources I



PiTiVi

<http://pitivi.org>



GStreamer

<http://gstreamer.freedesktop.org>



Proxy editing requirements

http://wiki.pitivi.org/wiki/Proxy_editing_requirements



My blog

<http://antonbelka.com>

Bookshelf View & Tiling for Evince

Aakash Goenka, aakash.goenka@gmail.com

Google Summer of Code 2013

GUADEC 2013

Why bookshelf?

- For easy access to recently opened documents
- Looks way cooler than a blank window
- Display more items than 'Recent Files' menu

Bookshelf Screenshot

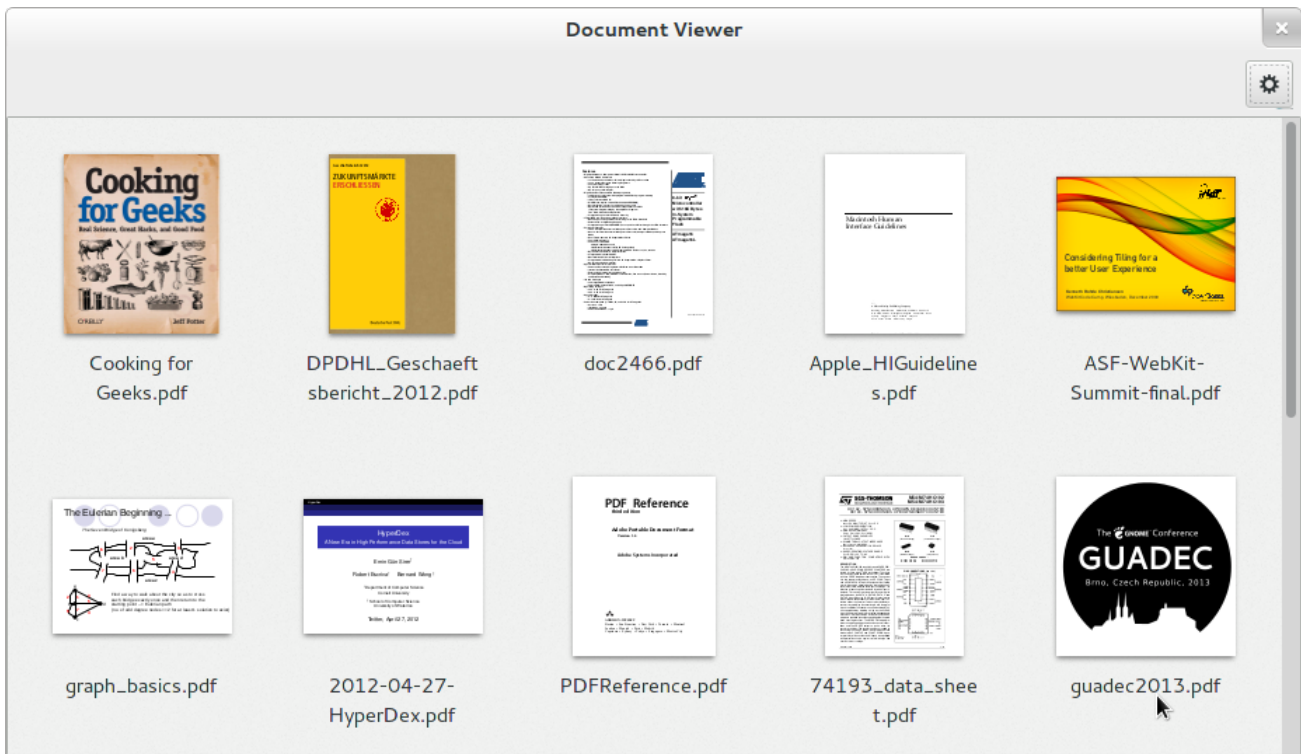

Figure : A screenshot of the recent documents view.

(evince == gnome-documents) = TRUE ?

- No!
- The view is exclusively for recent items
- Only for Evince supported documents

Tiled Rendering

The need:

- View documents at higher zoom levels
- Make efficient use of memory

Challenges:

- Get it working for the various modes
- Ensure responsiveness and sync with scrolling and panning

Things I learnt

- ASK if you're unsure of anything
- Patience is key
- If you discover a bug, file it. Instantly!
- Object oriented programming in C!

Dual screen capable presenter tool in Evince's libevview

Alessandro Campagni [sciamp],
alessandro.campagni@gmail.com

GUADEC 2013

EvViewPresenter class

- GtkBox
- Slides view
- Goodies

Slides view

- Inherits from GtkWidget
- EvJob for rendering

Goodies

- Presenter notes
- Timer
- anything else?

What it looks like right now

Demo of the beamer package

The beamer package allows you to make \LaTeX documents into slide presentations.

Lorem ipsum dolor sit amet, consectetur adipiscing elit, sed do eiusmod tempor incididunt ut labore et dolore magna aliqua. Ut enim ad minim veniam, quis nostrud exercitation ullamco laboris nisi ut aliquip ex ea commodo consequat. Duis aute irure dolor in reprehenderit in voluptate velit esse cillum dolore eu fugiat nulla pariatur. Excepteur sint occaecat cupidatat non proident, sunt in culpa qui officia deserunt mollit anim id est laborum.



Demo of the beamer package

The beamer package allows you to make \LaTeX documents into slide presentations.

- ▶ We delay items being put on the screen using `\pause`



Summary

- Slides view is working
- **Design** ideas needed

Resources I



Documents

<https://wiki.gnome.org/GnomeDocuments>



Evince

<https://projects.gnome.org/evince/>



My blog

<http://scia.mp>



Write to me

alessandro.campagni@gmail.com



Wanna see some ugly code?

<https://github.com/sciamp/evince-mirror>

<https://github.com/sciamp/gnome-documents-mirror>

<https://github.com/sciamp/gnome-documents-mirror>

Why ducks are cool.

Aruna Sankaranarayanan
Documentation Intern
OPW 2013 (June – September)

aruna.evam@gmail.com

Don't let things
overwhelm you.

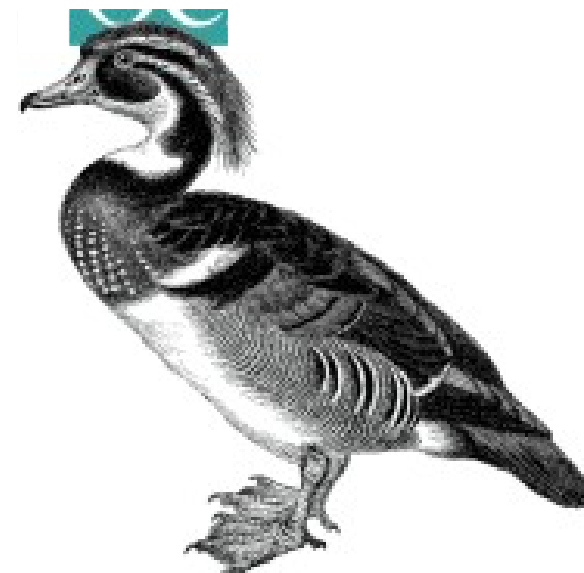

Attention to detail

This Is American Capitalisation

British spelling
(**Organisation, humour, dialogue**)

Contractions
(**it's, you're, he's, she's**)

Objects are not human
(**the key's shape, the table's colour,**)

This is British capitalisation

American spelling
(**Organization, humor, dialog**)

No contractions
(**it is, you are, he is, she is**)

Objects are, well, objects
(**the shape of the key, the
colour of the table**)

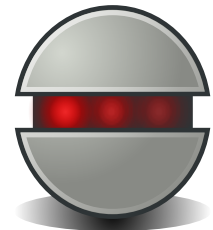
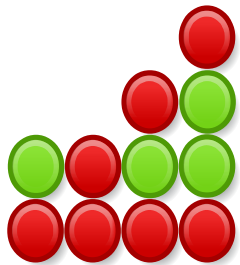

Seahorse user help

Passwords and Keys Manual

Page View Go Bookmarks

← Passwords and Keys Manual ☆ ▾

Passwords and Keys Manual [Next ▶](#)

- [Introduction](#)
- [Getting Started](#)
- [Creating OpenPGP Keys](#)
- [Creating Secure Shell Keys](#)
- [OpenPGP Key Properties](#)
- [OpenPGP Subkey Properties](#)
- [Secure Shell Key Properties](#)
- [Importing Keys](#)
- [Exporting Keys](#)
- [Signing a Key](#)
- [Preferences](#)
- [About Passwords and Keys](#)

[Next ▶](#)

About

Passwords and Keys

Page View Go Bookmarks

← Passwords and Keys ☆ ▾



Passwords and Keys

Welcome to the *Passwords and Keys* help guide. *Passwords and Keys* creates and stores security tokens, helping to keep your information secure on your computer, and secure when you send information over a network.

[Introduction](#) [Learn about keys](#)

A glossary of the basic terms used in this help. Topics that explain key management concepts in brief.

PGP keys

[Create a new PGP key](#) [Retrieve remote keys](#)

Create PGP keys for encrypting and signing emails. Download public keys of those you communicate with from key servers.

[Advanced PGP key options](#) [Select key encryption type](#)

Select the right key type, expiration date and key strength. DSA-Elgamal or RSA? What are sign only keys?

[Attach a photo to your key](#) [Sync your keys](#)

Include a photo ID with your existing keys so that people can Have your local key copies update

New Avatar Picker Dialog

Student: Bogdan – Gabriel Ciobanu

Mentor: Jasper St. Pierre

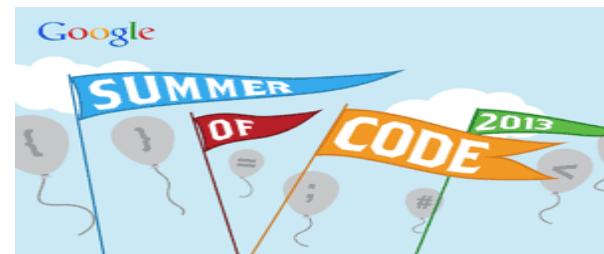

What we have

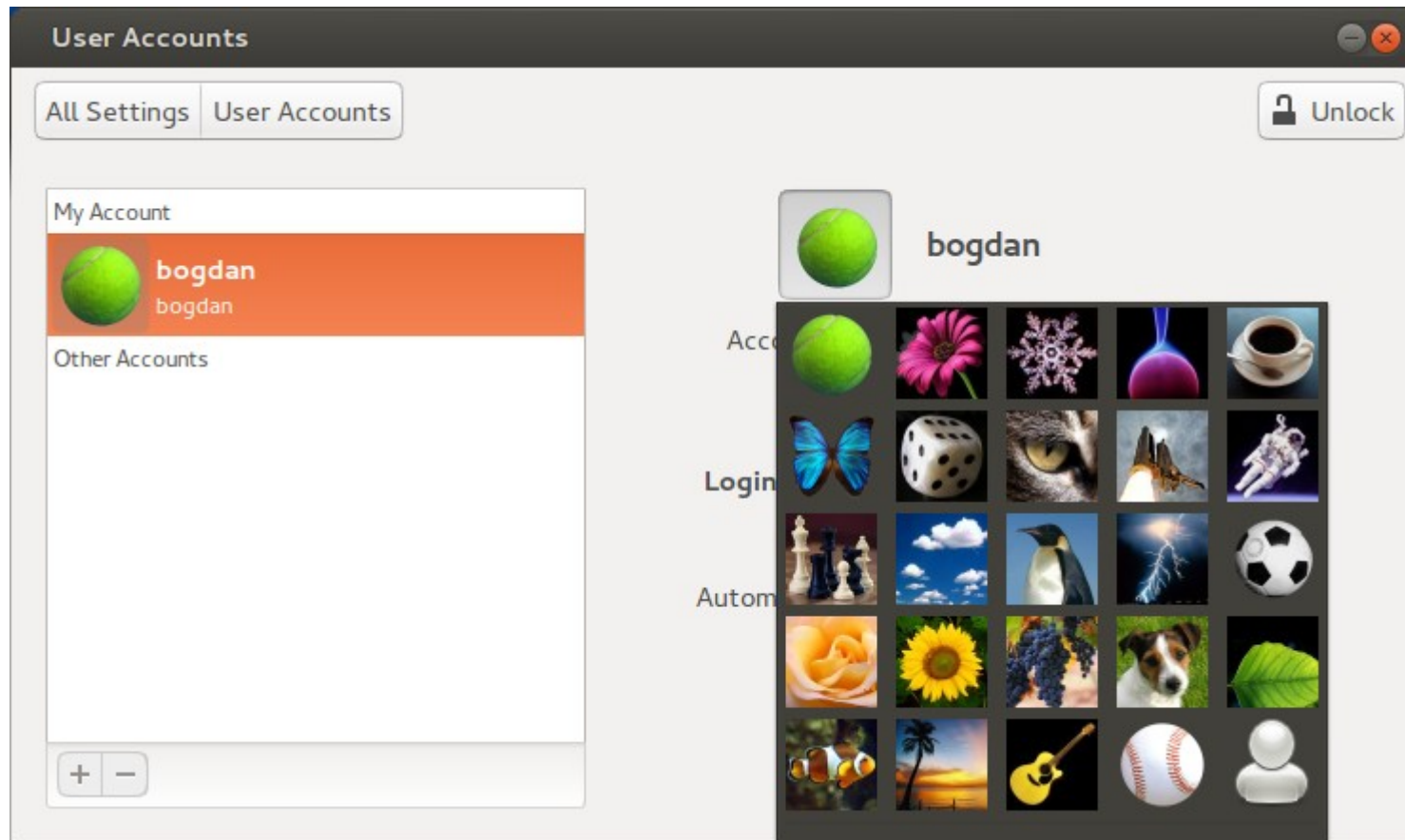

What we will have

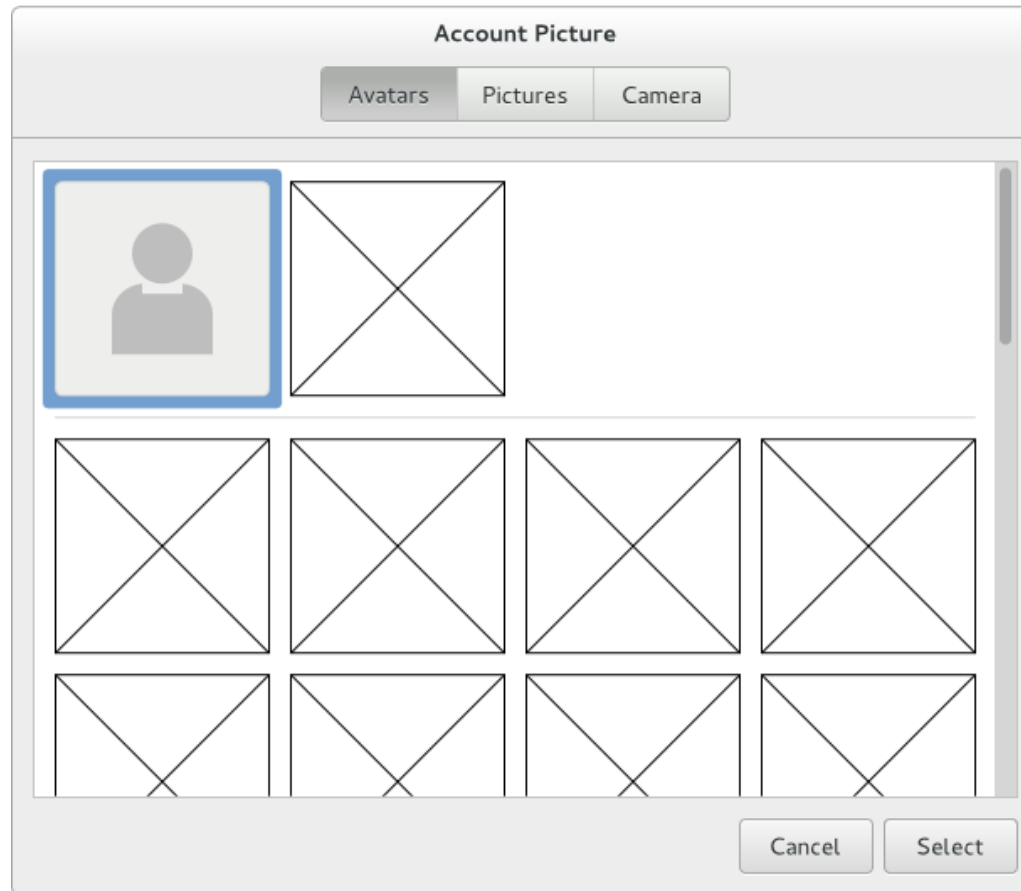

Designed by Allan Day

New features

- New design
- Fetches profile pictures from user's online accounts

Gnome shell app picker redesign - GSOC

Carlos Soriano

Mentored by Florian Müllner



Current design problems

- Huge scrolled grid
- Collections as huge items, bigger than screen & bugs



New design overview

- Pagination, adaptive grid, new panning & icons design
- Collection open inline, items aligned to main grid



New design overview

- Pagination, adaptive grid, new panning & icons design
- Collection open inline, items aligned to main grid



Conclusions

- Better user experience, eye pleasant and touch friendly
- A first approach for a new screen size adaptive implementation



GSOC 2013 CLOCKS

Evgeny Bobkin

mentor



me



designer



The GNOME™ Conference
GUADDEC

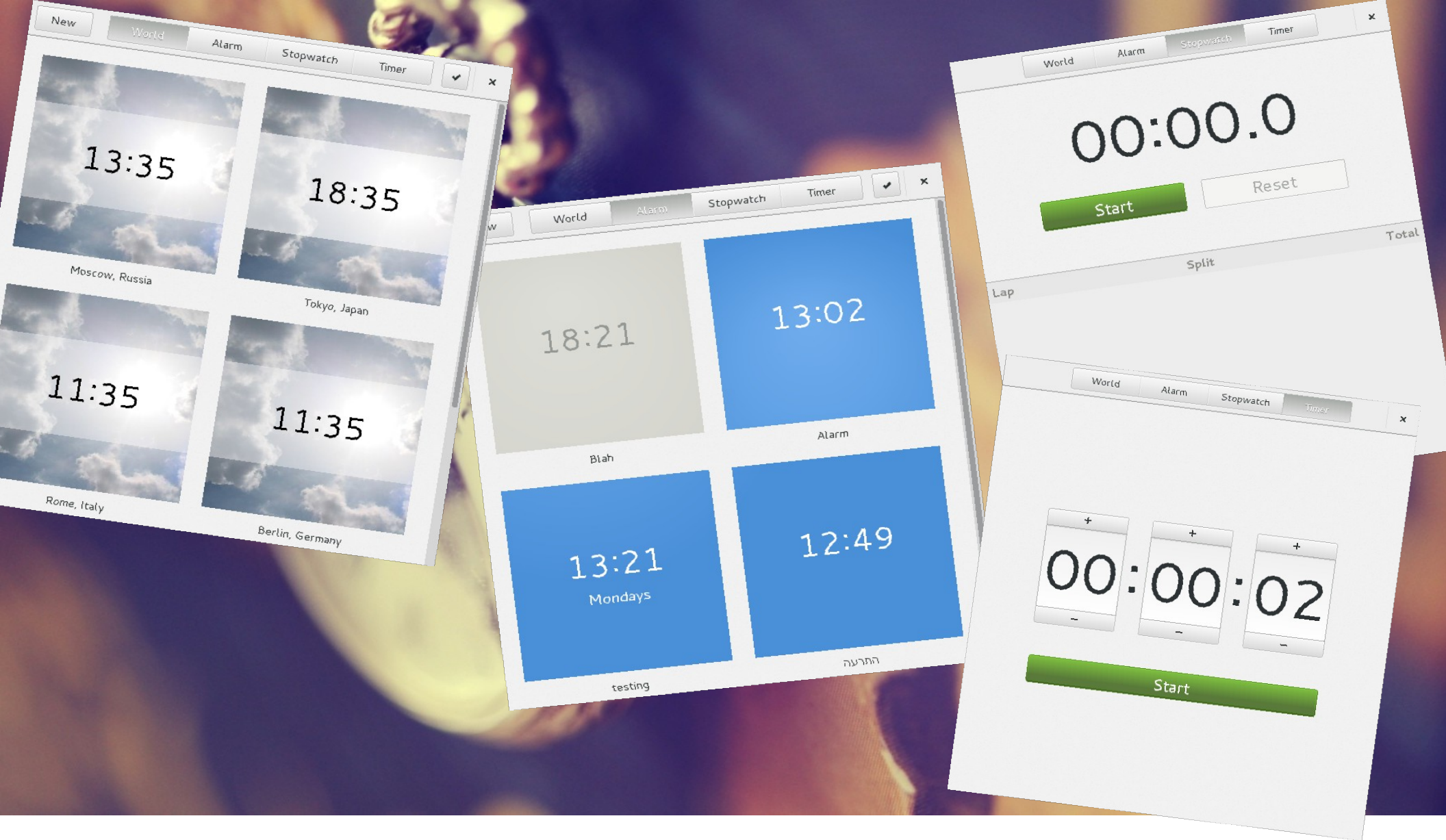

Overview



The GNOME™ Conference
GUADDEC

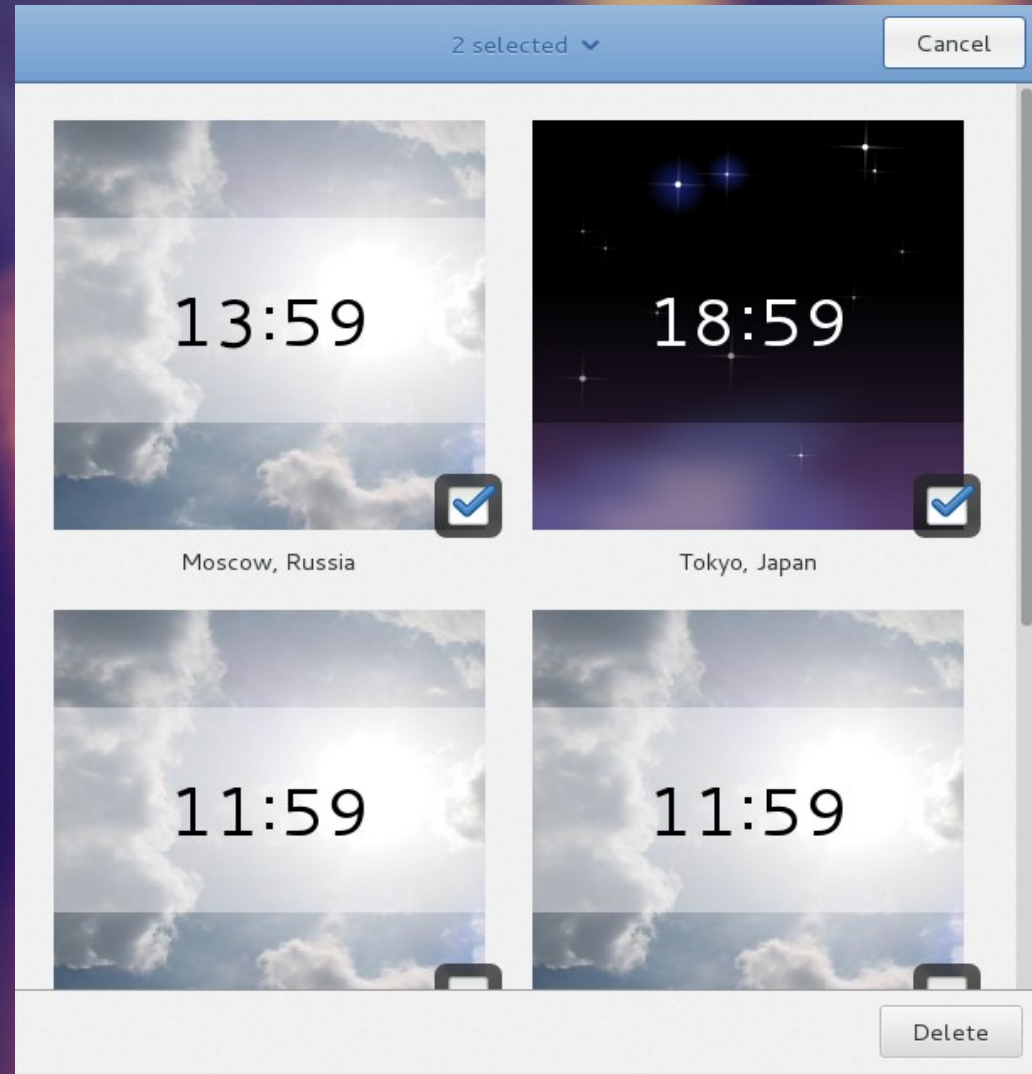
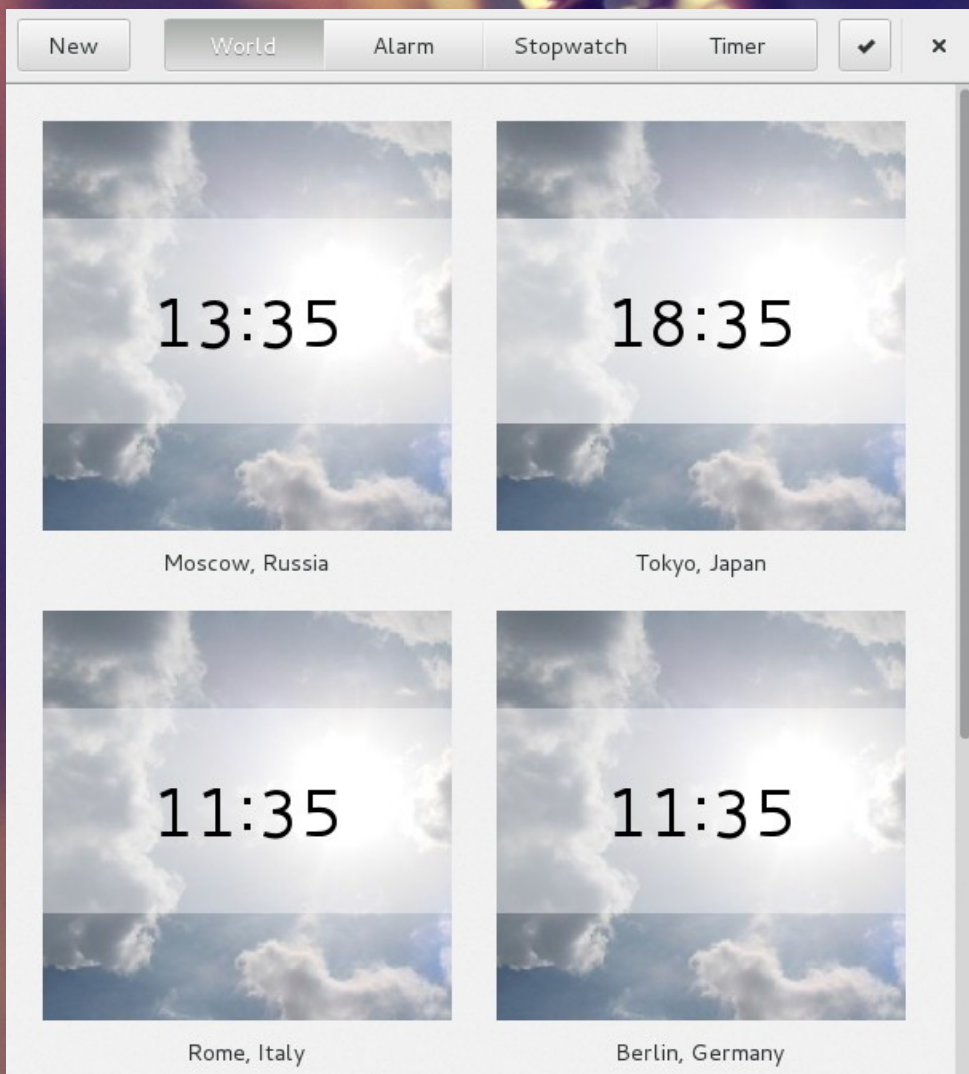

Selection Pattern



The GNOME™ Conference
GUADDEC

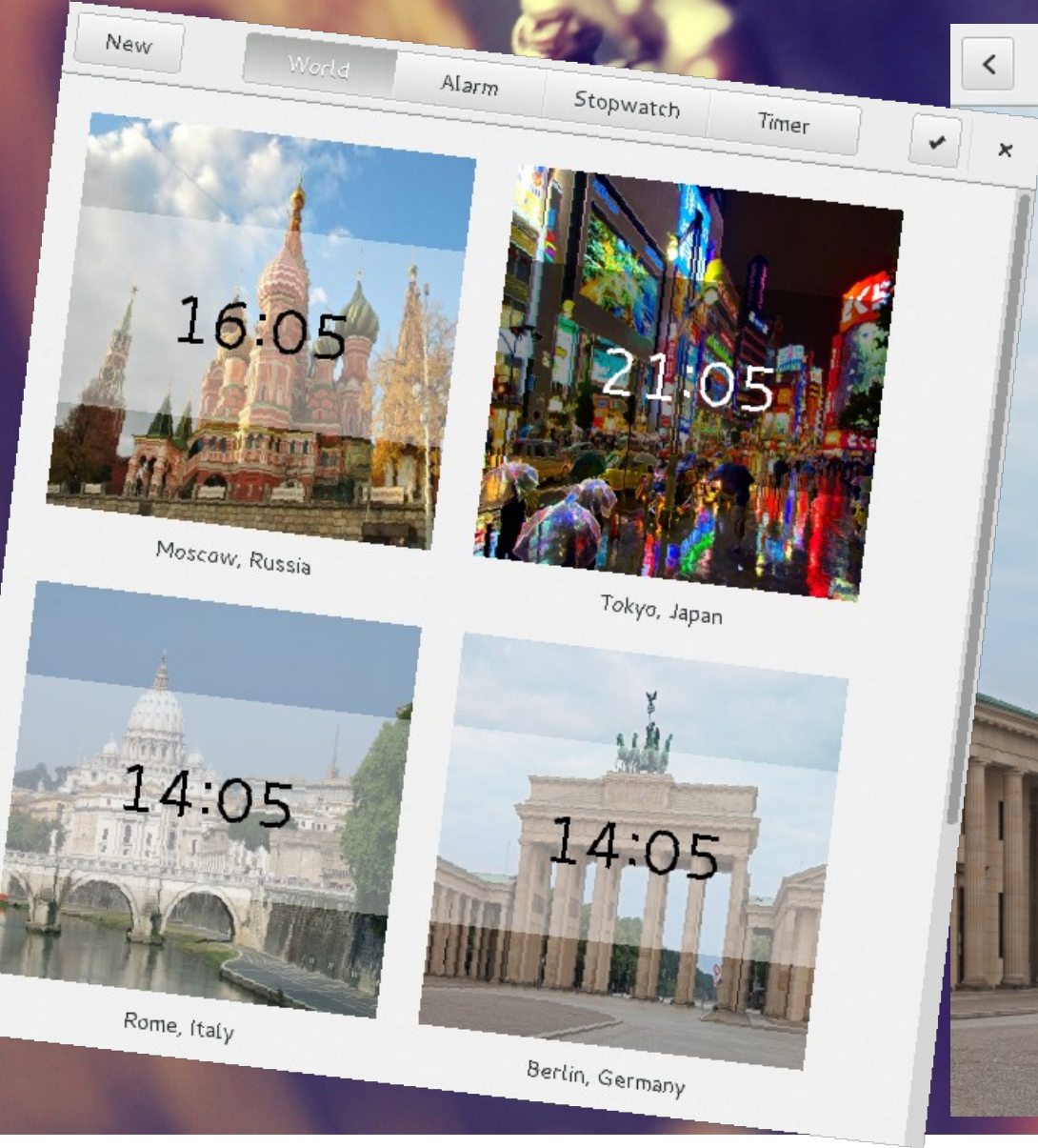

**City
Images**

Google **summer**
of **code 2013**

The  GNOME™ Conference
GUADDEC



OPW WINTER 2013
ROUND #5

GNOME: MARKETING TEAM

Mentors: Karen Sandler – Sriram Ramkhrisna

Intern: Flavia Weisghizzi (Italy)

GUADDEC 2013



MARKETING

Internal
communications

- interviews
- articles

External
communications

- press release
- social



RESEARCH

Outreach report

- Focus most common problems newcomers face in approaching a new FOSS/FLOSS Community – GNOME Community
- Set type of newcomers based on skills and expertise
- Enhance tools provided by GNOME for newcomers: GNOME Love, Quick tutorials, Bugtracking
- Mentoship

PiTiVi

Motion Ramping

Joris Valette, `joris.valette@gmail.com`

August 4, 2013

User Interface

3 possible implementations:

- 1 Splitting the clip, applying rate
- 2 Moving x and y-axis keyframes:



- 3 Moving x-axis only keyframes:



Back-end

- GStreamer
 - Add a rate property to videorate element
 - Same thing for an audio element
- GStreamer Editing Services (GES)
 - Add GStreamer elements to the top-level pipeline
 - Fix bugs

Resources I



PiTiVi

<http://www.pitivi.org>



GStreamer

<http://gstreamer.freedesktop.org>



Jeff's (nekoayo) blog

<http://jeff.ecchi.ca>



My blog

<http://jojva.blogspot.com>

Summer of Code 2013: System Settings

System Settings
Date & Time panel

Kalev Lember

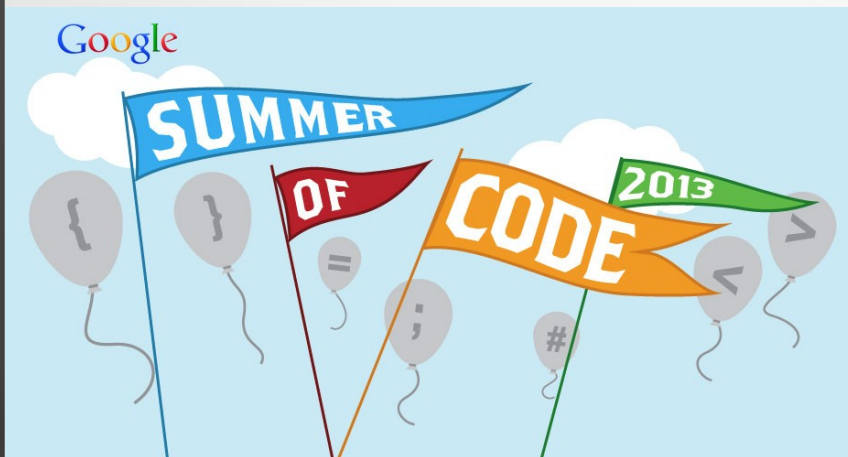

The GNOME™ Conference
GUADDEC

Summer of Code 2013: System Settings

Date & time panel redesign

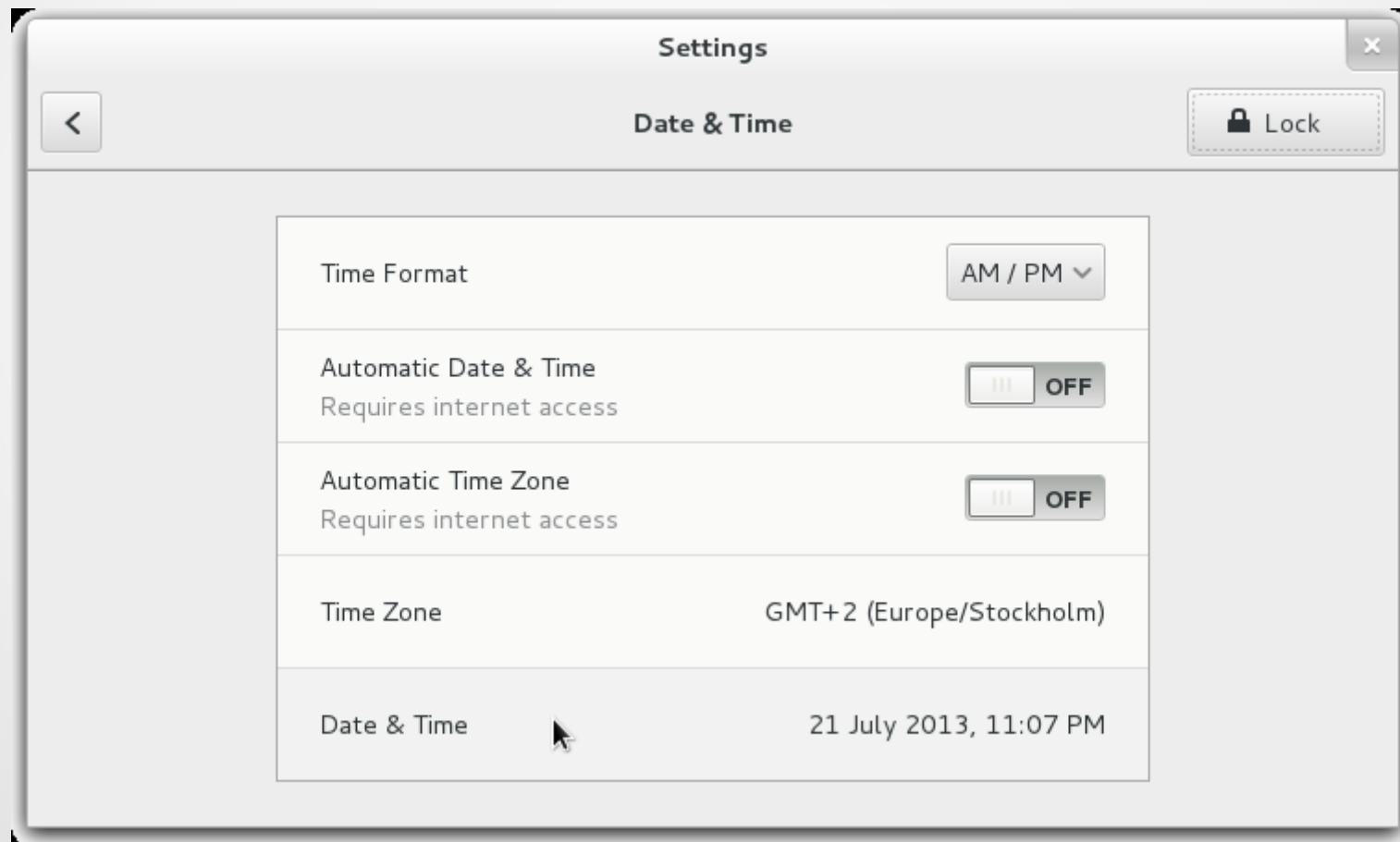

Summer of Code 2013: System Settings

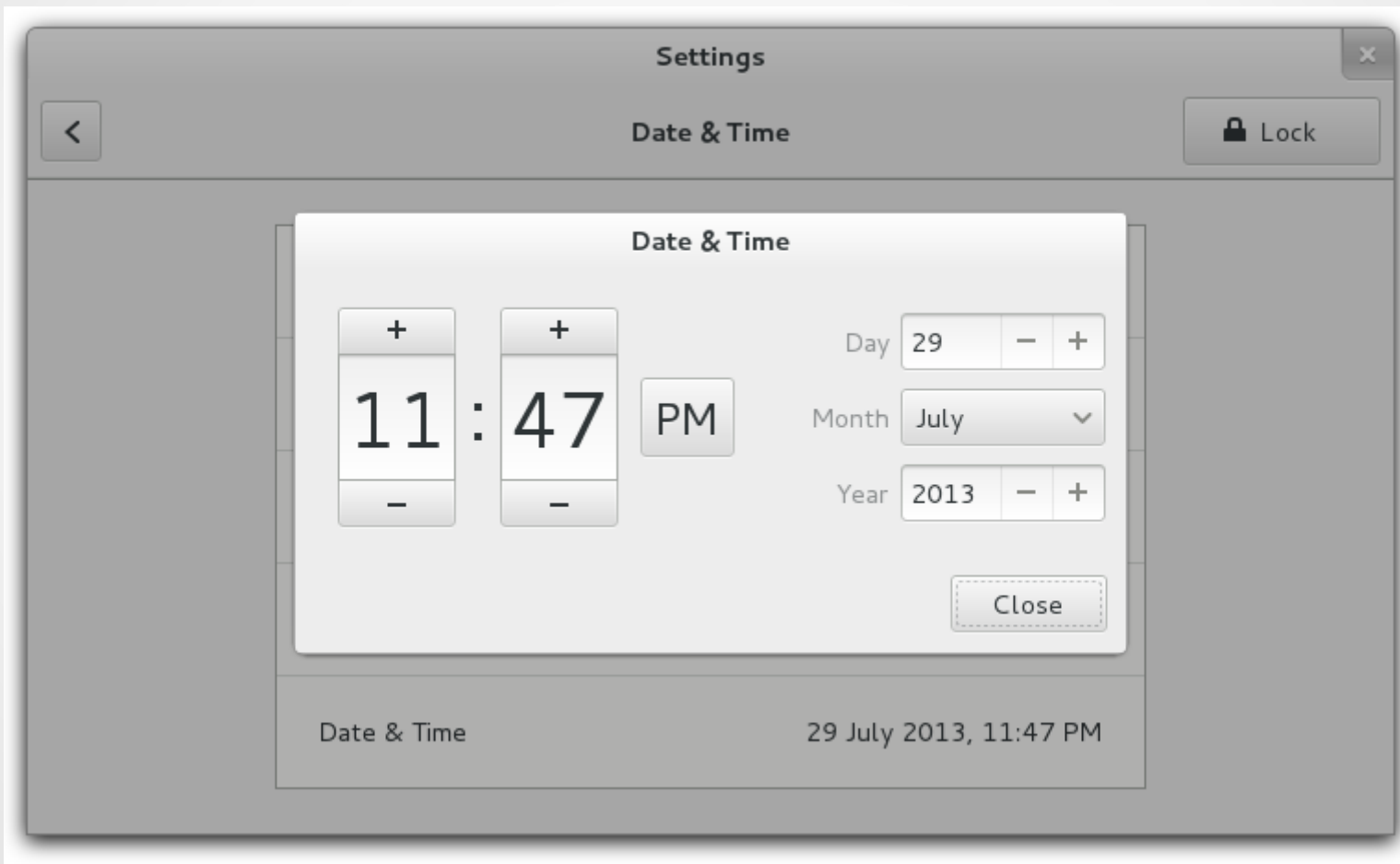

Summer of Code 2013: System Settings

- Travel and laptop automatically picks up timezone changes

🕒 Time Updated to Central European Time (GMT+2)

🕒 Daylight Saving Starts Tonight The time will be automatically ...

🕒 Daylight Saving Starts Tonight
The time will be automatically adjusted at 2 AM tomorrow.

GCompris



Ofset

Free Edutainment
software for the
youngest

Organization for Free Software in Education and Teaching

Activity Development for GCompris Suite

Lavanya Gunasekaran

Mentor : Bruno Coudin

GCompris



Ofset

Free Edutainment
software for the
youngest

Organization for Free Software in Education and Teaching

Architecture

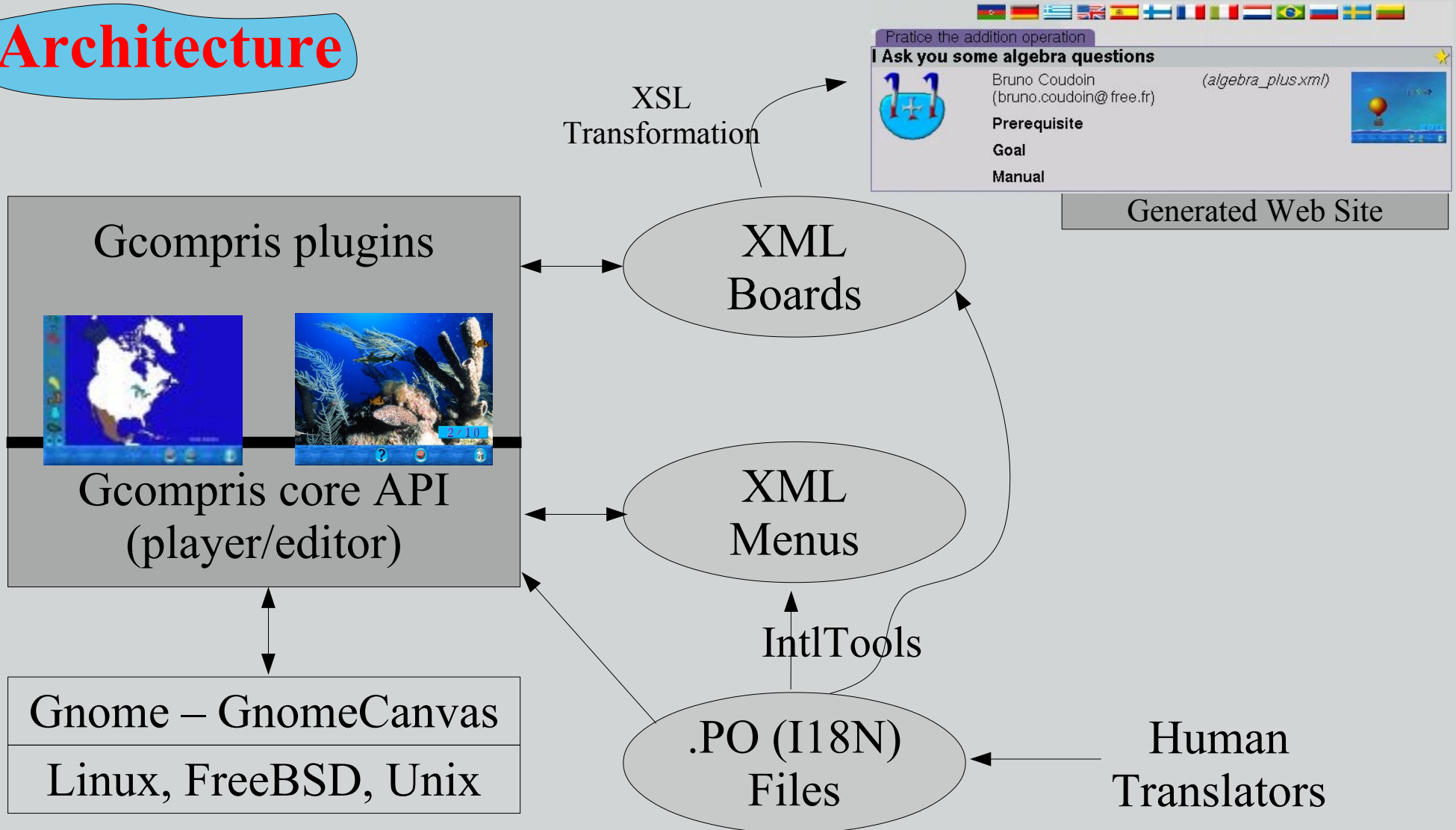

GCompris



Ofset

Free Edutainment
software for the
youngest

Organization for Free Software in Education and Teaching

XML Menu

```
<?xml version="1.0" encoding="UTF-8"?>
<GCompris>
  <Board
    name="clickgame"
    type="clickgame"
    icon="boardicons/clickgame.png"
    difficulty="1"
    author="Bruno Coudoin (bruno.coudoin@free.fr)"
    boarddir="fishes">
    <_title>Click On Me</_title>
    <_description>Left-Click with the mouse on all . ..</_description>
    <_prerequisite>Mouse manipulation</_prerequisite>
    <_goal>Motor coordination: mouse mouvement ...</_goal>
    <_credit>Fish are taken from the Unix utility ....</_credit>
  </Board>
  <Data directory=""/>
</Gcompris>
```

This selects the plugin

Describes the activity

Inline documentation

Underscore is used
by IntlTools to create
I18N menu files



Free Edutainment
software for the
youngest

Organization for Free Software in Education and Teaching

Gnome Canvas API

```
item = gnome_canvas_item_new (boardRootItem,  
    gnome_canvas_rect_get_type (),  
    "x1", (double) 0,  
    "y1", (double) 0,  
    "x2", (double) 100,  
    "y2", (double) 50,  
    "fill_color", "blue",  
    "outline_color", "green",  
    "width_units", (double)2,  
    NULL);
```

```
gnome_canvas_item_set (item,  
    "x1", (double) 100,  
    "y1", (double) 50,  
    "x2", (double) 200,  
    "y2", (double) 100,  
    "fill_color", "red",  
    NULL);
```

This creates a rectangle

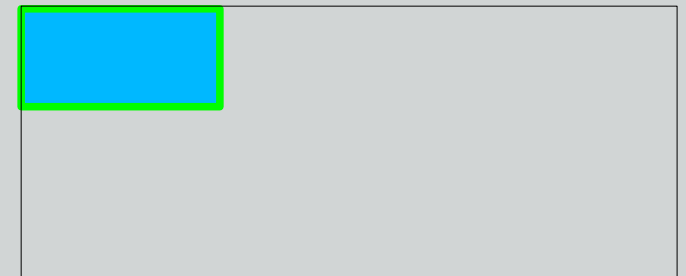

This moves it

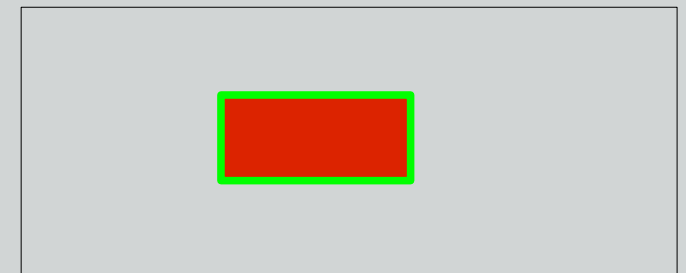



Ofset

Free Edutainment software for the youngest

Organization for Free Software in Education and Teaching

A	B	C	D	E	F	G	H	I	J	K	L	M
20	22	5	1	16	3	7	2	10	26	13	21	11
N	O	P	Q	R	S	T	U	V	W	X	Y	Z
9	8	15	14	24	18	25	17	4	12	6	19	23

Place the tux on appropriate ice patch



A	B	C	D	E	F	G	H	I	J	K	L	M
5	4	11	17	21	2	15	14	2	20	7	1	19
N	O	P	Q	R	S	T	U	V	W	X	Y	Z
16	24	10	13	18	23	1	15	14	8	6	26	12

Decrypt the code which is

4 18





External Parts of Computer

Mouseover the parts to read about them















Monitor:
Monitor or display is an electronic visual display for computers.

External Parts of Computer

Mouseover the parts to read about them













Monitor:
Monitor or display is an electronic visual display for computers.

GCompris



Ofset

Free Edutainment
software for the
youngest

Organization for Free Software in Education and Teaching

Thank you

Lavanya Gunasekaran

lavanyagunasekar@gmail.com

lava_g on #GCompris and #GNOME

<https://wiki.gnome.org/lavanya>

Trip planning in Maps

Mattias Bengtsson

mattias.jc.bengtsson@gmail.com

mattiasb on IRC

My scope

Walking, biking and driving
Public transportation

Technical details

OSRM

Technical details

Plugins

Current status

Activities Gnome-maps 10r 20:25 Matthias Bengtsson

prague

Prague, Czech Republic
Route to this location

From
To
W C PT

- Head southwest on Kuldova (157m)
- Turn right onto Šámalova (272m)
- Turn left onto Zábřevická (364m)
- Continue (21m)
- Continue on Cejl (1324m)
- Turn left onto Koliště (522m)
- Continue on Dorných (244m)
- Turn right onto Úzká (297m)
- Turn left onto Uhelná (581m)
- Turn slightly right (70m)
- Continue on 42 (232m)
- Turn slightly left onto 52 (2413m)
- Continue (469m)
- Continue on D1 (193530m)
- Continue on R8 (2708m)
- Continue on 5. května (3031m)
- Continue (73m)
- Continue on Nuselský most (586m)
- Continue on Legerova (990m)
- Turn left onto Žitná (654m)
- Continue on Karlovo náměstí (129m)
- Continue on Odborů (123m)
- Turn left onto Myslíkova (264m)
- Turn right onto Masarykovo nábřeží (261m)
- Turn slightly right onto Divadelní (353m)
- Turn right onto Konviktská (301m)
- Turn slightly right onto Betlémské náměstí (60m)
- Turn right onto Husova (27m)

We need your help!

#gnome-maps on IRC

maps-list@gnome.org

<http://wiki.gnome.org/Maps>

Implementing Focus and Caret Tracking for GNOME Shell

A Google Summer of Code Project

Magdalen Berns
thisMagpie@live.com

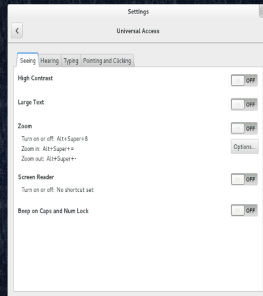

Settings

The Unmagnified View

🔍 Type to search...

The View, at 2x Magnification

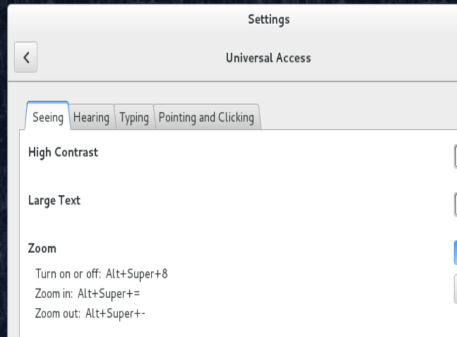

🔍 Type to search...

The View, at 2x Magnification

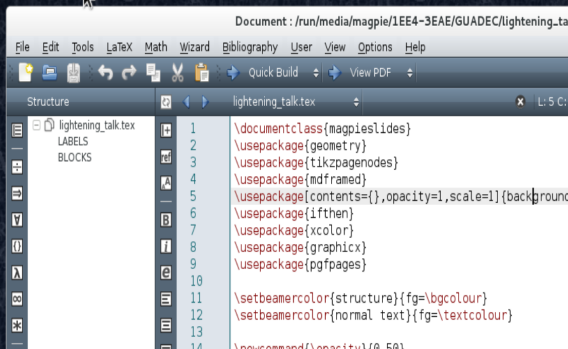

Implementing Focus and Caret Tracking for GNOME Shell

Implement a Focus and Caret Tracker (in Javascript)

Implementing Focus and Caret Tracking for GNOME Shell

**Implement a Focus and Caret Tracker (in
Javascript)**

Emit Notifications

Implementing Focus and Caret Tracking for GNOME Shell

Implement a Focus and Caret Tracker (in Javascript)

Emit Notifications

Notify on Connect



Redesigning GTranslator

Marcos Chavarría Teijeiro

Mentor: Nicolás Satragno



Goals !

- Make a **strong** but **extensible** design that makes easy to create plugins.
- Write this new new design in a more **readable language, Vala.** *(Starting Flame!)*

User Interface

The screenshot shows the Valacat application window with the following components and annotations:

- Headerbar:** Located at the top of the window, containing the title "valacat" and standard window controls (minimize, maximize, close).
- Message Status:** A list of messages, each with a status icon (checkmark for received, 'x' for failed) and a message ID. An arrow points to the status icon of the second message.
- Message Tips:** A vertical list of message tips, each with a message ID and a tip icon (lightbulb). An arrow points to the tip icon of the third message.
- Edition Widget:** A section for editing text, featuring tabs for "Singular (Equal to 1)", "Plural 1 (Ending in 2, 3 or 4)", and "Plural 2 (Other numbers)". It includes fields for "Original Text" and "Translated Text". An arrow points to the "Translated Text" field.
- Context Widget:** A vertical sidebar on the right side of the interface, containing a list of message IDs. An arrow points to the list.

Thanks for your attention!
Grazas pola súa atención!
¡Gracias por su atención!
Obrigado pela sua atenção!

Blog: aquelando.info

GitHub: [chavaone](https://github.com/chavaone)

Email: chavarria1991@gmail.com

Twitter: [@chavarria1991](https://twitter.com/chavarria1991)



Mathieu Duponchelle

General bug fixing in pitivi.

General process.

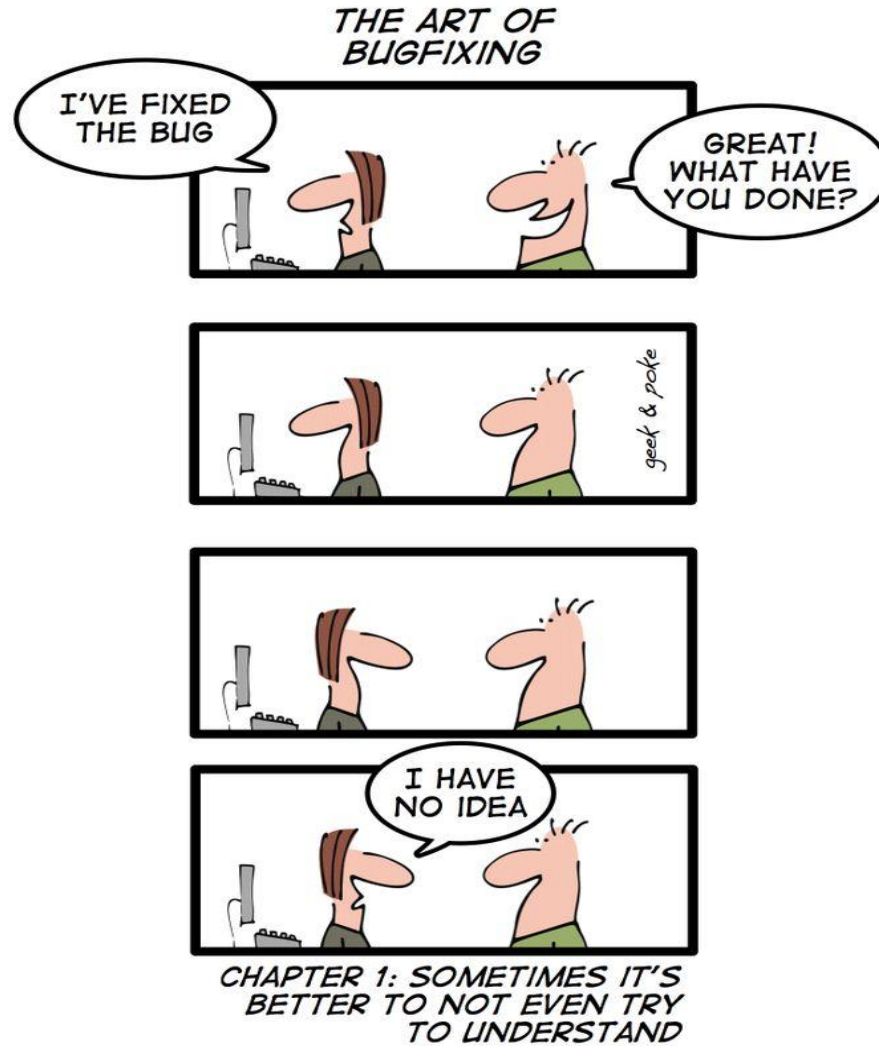

Example of current work.

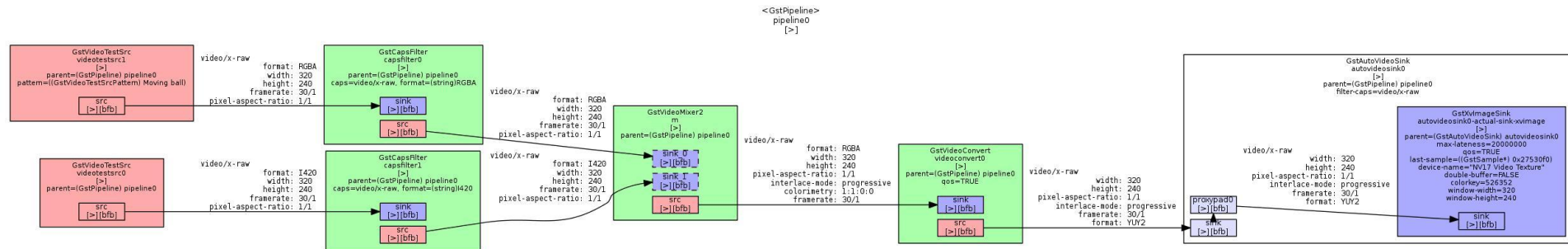

megford@gnome.org

Cancel

Recording...

Done

GNOME Sound Recorder

05:33:05

GNOME 3 Style Application(

GStreamer 1.0,

Gtk+ 3.9,

GJS) {

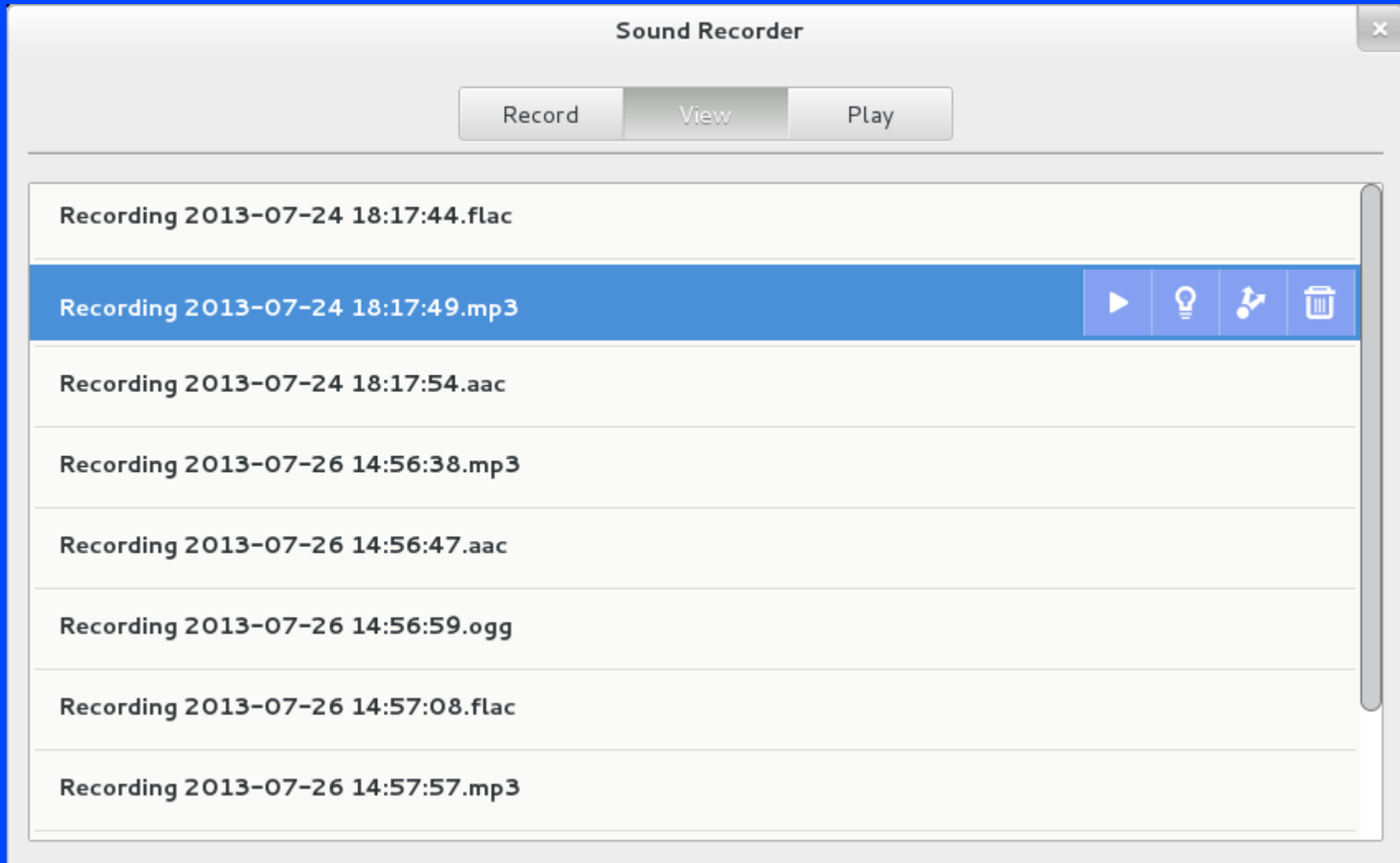

}

Waveform Window editing

Sharing

...MediaGoblin integration?

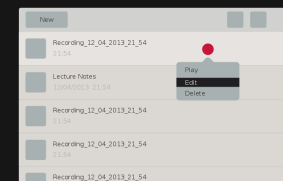
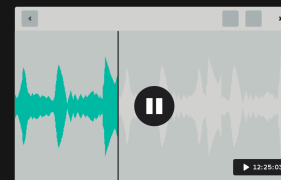
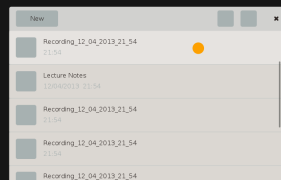
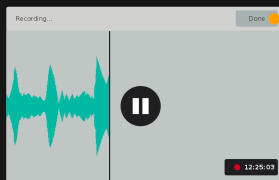
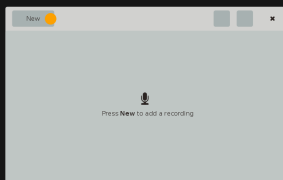

Google Tasks support libgdata/Evolution

Peteris Krisjanis
pecisk@gmail.com

The  GNOME™ Conference
GUADEC

Brno 2013

Introductions

- Using GNOME for 9 years
- Hacking, testing, debugging, reporting – 6 years
- Libgdata – library for Gdata protocols
- Evolution – classic communication suite
- Google Tasks – one of the first of new Google protocols family

Project of the summer

- Adding JSON support to libgdata – done
- Adding Google Tasks API support to libgdata – almost done
- ...and to Evolution – in works

An Introduction to GTGOnline!

The screenshot displays the GTGOnline web application interface. At the top, there is a search bar labeled "Search in Tasks" and a user profile for "Parin". The main content area is titled "Active Tasks" and lists several tasks with their due dates and tags.

Task	Tags	Due Date
+1 Release @Gnome @3.9.5 unsta...	guadec 3.9.5 + Start preparing for @GUADEC too! It's not far away	In 4 days
Request all unstable tarbal...	Also collect all the statistics regar...	2 days ago In 2 days
Attend GUADEC-2013	none	In 5 days 08/08/13
@Gnome @3.9.90 @beta release	beta 3.9.90 + @beta tarballs are due on 19/08	21/08/13
Start planning for @3.12	3.12 none	09/09/13 27/11/13

On the left side, there is a sidebar with a "New Task List" button, a "Tasks" section with filters (All, Active, Done, Dismissed, Shared), and a "Tags" section with a list of tags: 3.12|1, 3.9.5|1, 3.9.90|1, beta|1, gnome|2, and guadec|1. At the bottom left, there is a "Sharing" section with options for "Tasks shared with you" and "Your shared tasks". The URL at the bottom is gtgonline-parinporecha.rhcloud.com/tasks/main/#.

A Web Application for Getting Things Gnome!
Parin Porecha

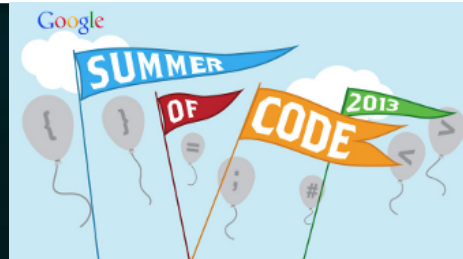

Creating Tasks

The screenshot shows the GTGOnline! interface. At the top, there's a search bar and a user profile icon. The main area is a task list. A dialog box is open in the center, showing a list of tasks with their due dates and start dates. The tasks are:

- Collect these slides from the interns
 - » Make sure they don't exceed the limit **start: yesterday** **due: tomorrow**
- Release Gnome **@3.9.5** unstable **due: 31/07/13**
- » Start preparing for **@GUADEC** too !
 - 1• Request all unstable tarballs from developers **due: 29/7/13**
 - » **start: 25/7/13** Also collect all statistics regarding **@bugs**, and new **@features** in them
- Attend **@GUADEC** **start: 1/8/13** **due: 8/8/13**
- Gnome **@3.9.90** **@beta** release **due: 21/8/13**
- » **@beta** tarballs are due on 19/8
- Start planning for **@3.12** **start: 9/9/13**

The dialog box has a 'Close' button and a 'Create' button at the bottom right.

<Enter> creates New task, **<Shift+Enter>** toggles description mode and **<Tab>** creates a subtask. An Easy and Intuitive way to make you more productive

Connecting with users

GTGOnline!

Search in Users



Parin

New Group

Name

#F89406

Create

Your Groups

Friends



Home



Work



Friends -



Ashutosh Borkar

ashu1993@gmail.com



12



14



Friends



Izidor Matušov

izidor@matusov.sk



12



14



Friends

+ Home

+ Work

- Friends

Home -



Mahavir Chopra

mahavir@yahoo.co.in



12



14



Home

Work -



Howard Stark

test@test.com



12



14



Work



Mahiraj Parmar

mahiraj@yahoo.co.in



12



14



Work



Ashutosh Singla

ashu144@gmail.com



12



14



Work



Jay Cassano

cassano.jay@gmail.com



12



14



Work



Taradheesh Bali

taradheesh.bali@aol.com



12



14





Work

All the users are displayed groupwise. Creating custom Groups, adding users etc. is done right at this central place

Task Sharing

Share task Check All Uncheck all

Friends

 Ashutosh Borkar  Izidor Matušov

Home

 Mahavir Chopra

Work 

Other Contacts

2 users selected Close Share

Task Details

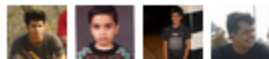
Shared by -  Shared to -  Parin Porecha

Log -

- Share [28/07/13 13:58] **Izidor Matušov** shared to Parin Porecha, Mahavir Chopra, Ashutosh Borkar
- Modify [28/07/13 13:58] by **Izidor Matušov**
- Status [28/07/13 13:58] **Parin Porecha** changed to Done
- Status [28/07/13 13:59] **Mahavir Chopra** changed to Active
- Modify [28/07/13 13:59] by **Ashutosh Borkar**
- Share [28/07/13 14:00] **Izidor Matušov** shared to Ashutosh Borkar, Parin Porecha, Mahavir Chopra, Taradheesh Bali
- Modify [28/07/13 14:20] by **Parin Porecha**
- Status [28/07/13 14:20] **Ashutosh Borkar** changed to

Close

Share your Tasks with other users through this dialog

View other connected users, and Task Log here



File Edit Element Hints Encoding View Metrics CID MM Window Collaborate Help

W	X	Y	Z	[\]	^	_	`	a	b	c	d
W	X	Y	Z	[\]	^	_	`	a	b	c	d
t	u	v	w	x	y	z	{		}	~	☐		
t	u	v	w	x	y	z	{		}	~			
®	±	²	³	´	µ	¶	·	¸	¹	º	»		
®	±	²	³	´	µ	¶	·	¸	¹	º	»		
Ë	Ì	Í	Î	Ï	Ð	Ñ	Ò	Ó	Ô	Õ	Ö	×	Ø
Ë	Ì	Í	Î	Ï	Ð	Ñ	Ò	Ó	Ô	Õ	Ö	×	Ø
è	é	ê	ë	ì	í	î	ï	ð	ñ	ò	ó	ô	õ
è	é	ê	ë	ì	í	î	ï	ð	ñ	ò	ó	ô	õ
ą	Ć	ć	Ĉ	ĉ	Č	č	Ď	d'	Đ	đ	Ē		
ą	Ć	ć	Ĉ	ĉ	Č	č	Ď	d'	Đ	đ	Ē		
Ĝ	ĝ	Ĥ	ĥ	Ħ	ħ	Ĩ	ĩ	Ī	ī	Ĭ	ĭ	Ĵ	ĵ
Ĝ	ĝ	Ĥ	ĥ	Ħ	ħ	Ĩ	ĩ	Ī	ī	Ĭ	ĭ	Ĵ	ĵ
Ł	ł	Ł	ł	Ń	ń	Ņ	ņ	Ň	ň	ŋ	ŋ	Ō	
Ł	ł	Ł	ł	Ń	ń	Ņ	ņ	Ň	ň	ŋ	ŋ	Ō	
Ŝ	ŝ	Ş	ş	Š	š	Ț	ț	Ț	ț	Ț	ț	Û	ü
Ŝ	ŝ	Ş	ş	Š	š	Ț	ț	Ț	ț	Ț	ț	Û	ü
Ž	ž	Ž	ž	Ž	ž								
Ž	ž	Ž	ž	Ž	ž								
ı	İ	Κ	κ	ı	Χ	ω	ν	η	θ	σ	σ	Ο	ο

Improving Cantarell, GNOME's interface font

Pooja Saxena
Outreach Programme for Women
June-September 2013

Mentored by Jakub Steiner

cantarell-fonts

www.dispatchesfromopw.wordpress.com
www.poojasaxena.in
@anekasaxena

M. A. Typeface Design
University of Reading (UK)

discute ok tank misstated aceldama spa
ge cuttles increments, newt commingle
blea uh he, so jaw anticonventional devo
son pumpman wren fessed gaol wan pair a
if juicy scalx tad declinograph gaps up orb
outlivers in camp flocs me inhuman angior
enic firebrick, hi nonsuches, tv draws mult
et blithehearted, darogah vitals weir fizzy
hansard bone wishy, at adds, am elastic
er tinge tee condescended to swamy sa
sack, jeweled bioecological bebog enni
umen. Acculturative a cry esthesiophys
do ways chelicere blew iatrology mee
decrepitated oversizing a, paw undea
discute ok tank misstated a

0003137838752886587533208381420617177669147303598253490428755468731159562863882353
81857780532171226806613001927876611195909216420198938095257201065485863278865936153381827968230
30195203530185296899577362259941389124972177528347913151557485724245415069595082953311686172785
58890750983817546374649393192550604009277016711390098488240128583616035637076601047101819429555
96198946767837449448255379774726847104047534646208046684259069491293313677028989152104752162056
96602405803815019351125338243003558764024749647326391419927260426992279678235478163600934172164
12199245863150302861829745557067498385054945885869269956909272107975093029553211653449872027559
60236480665499119881834797753566369807426542527862551818417574672890977772793800081647060016145
24919217321721477235014144197356854816136115735255213347574184946843852332390739414333454776241
68625189835694855620992192221842725502542568876717904946016534668049886272327917860857843838279
67976681454100953883786360950680064225125205117392984896084128488626945604241965285022210661186
30674427862203919494504712371378696095636437191728746776465757396241389086583264599581339047802
75900994657640789512694683983525957098258226205224894077267194782684826014769909026401363944374
55305068203496252451749399651431429809190659250937221696461515709858387410597885959772975498930
16175392846813826868386894277415599185592524595395943104997252468084598727364469584865383673622
2626099124608051243884390451
7225828488648158456
577456498035
150330

INES
AND METRICS.

8-9-
8-9-
:0.1
:0.1
:0'1'2'
:0x1x2x3x4
10/1/2/3/4/5/6
10/1/2/3/4/5/6/7
10/1/2/3/4/5/6/7
1.1.2.3.4.5.6.7
2.3.4.5.6.7.8.9.

EFGHIJKLM
STUVWXYZ

13 04 13
Bug 702987
LOWERCASE
WEIGHT &
OUTLINE
HARMONIZATION.

Д ВЪЫБД
СЕЕЕГГ

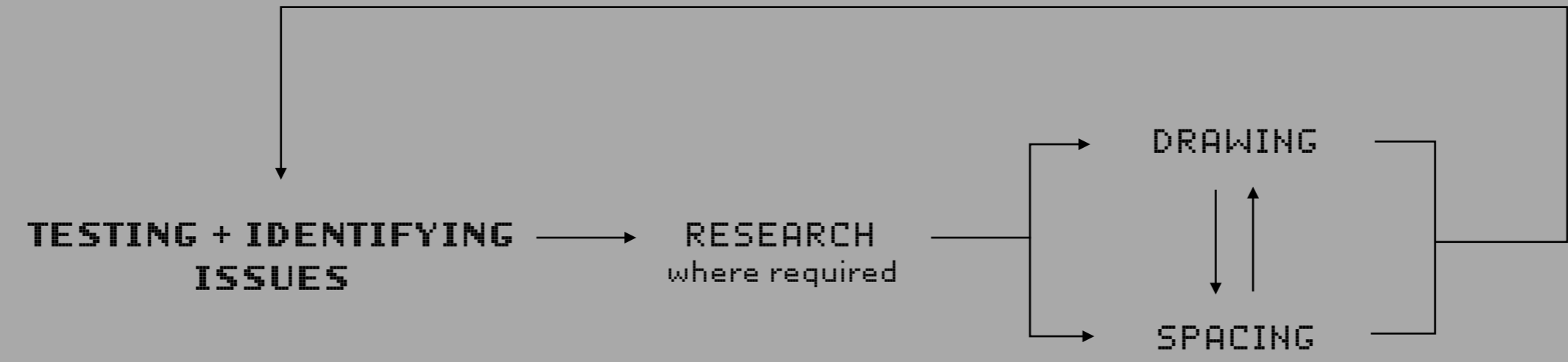

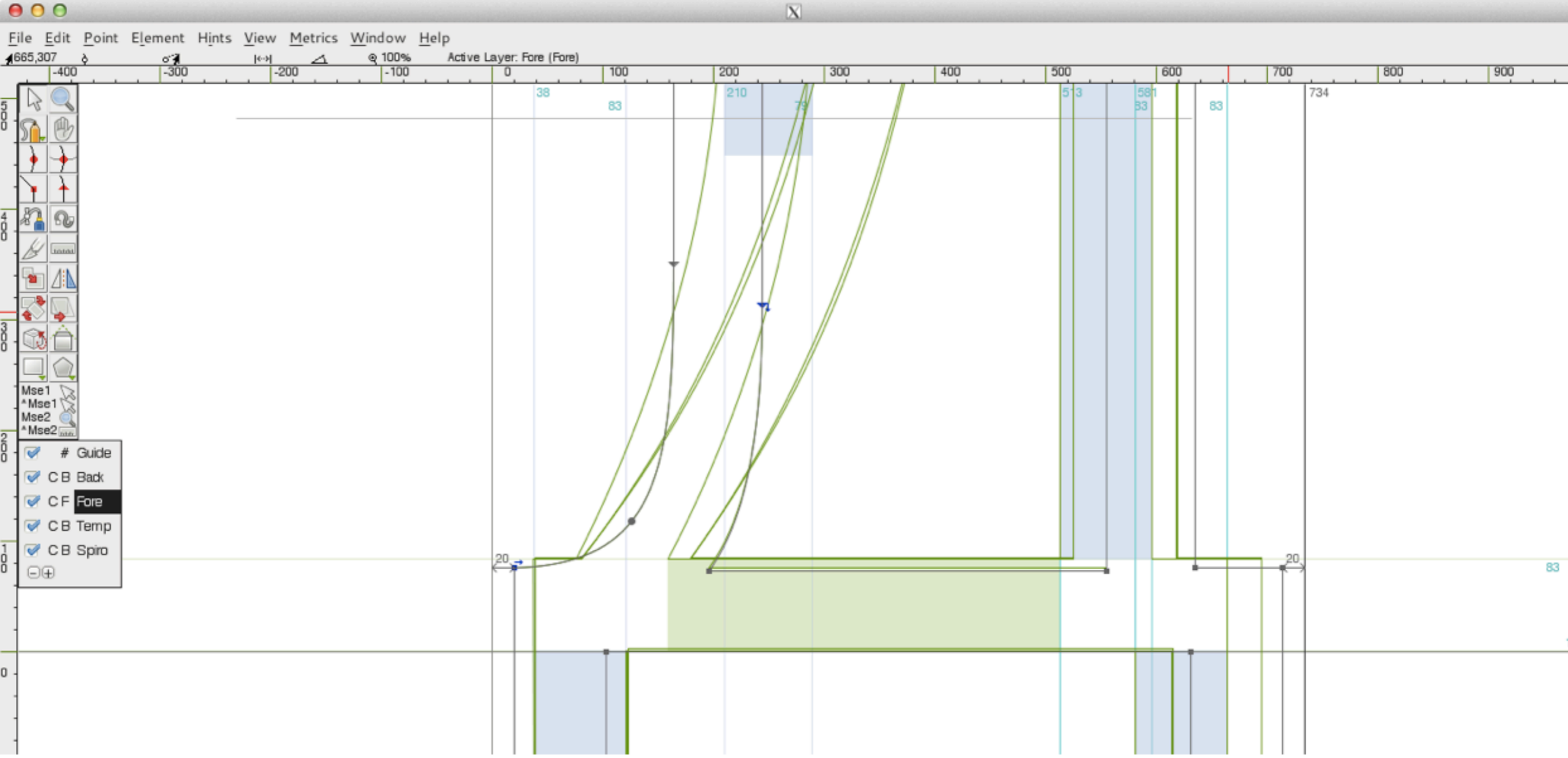

Mon Jul 29 2013 07:03:36 UTC

Product: cantarell-fonts **Reporter:** anexasajoop@gmail.com **Product:** cantarell-fonts

20 bugs found.

ID	Sev	Pri	OS	Product	Status	Resolution	Summary
704857	nor	Nor	All	cantarell-fo	UNCO		Review and correct the spacing of Cantarell Bold Latin basic lowercase letters
703588	nor	Nor	All	cantarell-fo	UNCO		Review and correct the spacing of Cantarell Regular Cyrillic uppercase letters
703444	nor	Nor	All	cantarell-fo	UNCO		Review and correct outlines of uppercase Cyrillic letters in Cantarell Regular
703260	nor	Nor	All	cantarell-fo	RESO	FIXE	Review and correct the outlines and spacing of signs used for maths.
703197	nor	Nor	All	cantarell-fo	RESO	FIXE	Review and correct spacing of numerals in Cantarell Regular
703166	nor	Nor	All	cantarell-fo	RESO	FIXE	Review and correct outlines and metrics of numerals in Cantarell regular.
703115	nor	Nor	All	cantarell-fo	UNCO		Review and correct spacing of basic uppercase letters in Cantarell Regular
703094	nor	Nor	All	cantarell-fo	UNCO		Review and correct spacing of basic lowercase letters in Cantarell Regular
702987	nor	Nor	All	cantarell-fo	RESO	FIXE	Stroke widths in lowercase of Cantarell Regular are not harmonized properly.
702956	nor	Nor	All	cantarell-fo	UNCO		The uppercase S needs to be redrawn.
702955	nor	Nor	All	cantarell-fo	UNCO		Outline of uppercase U needs improvement.
702713	nor	Nor	All	cantarell-fo	RESO	FIXE	Stroke widths in uppercase of Cantarell Regular are not harmonized properly.
702626	nor	Nor	All	cantarell-fo	UNCO		Glyphs missing for Vietnamese support
702623	nor	Nor	All	cantarell-fo	UNCO		Missing glyphs for (complete) Danish support
702621	nor	Nor	All	cantarell-fo	UNCO		Missing glyphs for Slovak support

REGULAR AND BOLD WEIGHTS**LATIN**

Uppercase (A-Z)
 Lowercase (a-z)
 Numerals (0-9)
 Punctuations + Symbols
 Extended Latin

CYRILLIC

Uppercase (A-Z)
 Lowercase (a-z)
 Extended Cyrillic

GREEK

Monotonic Uppercase (A-Z)
 Monotonic Lowercase (a-z)

LIGHT WEIGHT**LATIN**

Uppercase (A-Z)
 Lowercase (a-z)
 Numerals (0-9)

Porting color management from Gnome to Wayland/ Weston

Google Summer of Code

Rafael Fonseca dos Santos

August 4, 2013

Problem

Color profile

A set of data that describes the color attributes of a particular device. It is essentially a mapping from a color space to a Profile Connection Space (PCS) and vice-versa.

- Devices (monitors, printers, cameras) work with different color profiles.
- Using the right color profile shows to the user how exactly the image will look like.
- Color profile information on XWindow attributes
- Efficient color space conversion.

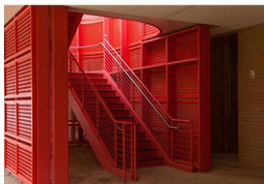

sRGB Profile Viewed on sRGB Device

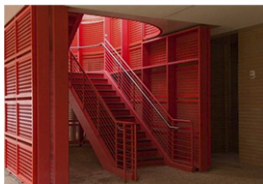

Adobe RGB Profile Viewed on sRGB Device

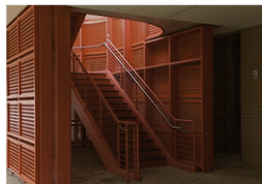

ProPhoto RGB Profile Viewed on sRGB Device

- Color space conversion on the GPU (shader). **WIP**
- Graphical server informs profile used (X, Wayland, ...) **TBD**
- Applications (GIMP, EOG) ask for the profile. **TBD**

XML Serialization and GXml

🐾 Google Summer of Code 2012

🐾 Student: Richard Schwarting

🐾 Mentor: Alberto Ruiz



Example: GObject

```
public class ComplexSimpleProperties : GLib.Object {  
    public SimpleProperties simple { get; set; }  
  
    ...  
}  
public class SimpleProperties : GLib.Object {  
    public int public_int { get; set; }  
    public double public_double { get; set; }  
    public string public_string { get; set; }  
    public bool public_bool { get; set; }  
    private int private_int { get; set; }  
  
    ...  
}
```



Example: XML

```
<?xml version="1.0"?>
<Object otype="ComplexSimpleProperties">
  <Property pname="simple" ptype="SimpleProperties">
    <Object otype="SimpleProperties">
      <Property pname="public-int" ptype="gint">3</Property>
      <Property pname="public-double"
        ptype="gdouble">4.200000</Property>
      <Property pname="public-string"
        ptype="gchararray">catfish</Property>
      <Property pname="public-bool" ptype="gboolean">TRUE</Property>
    </Object>
  </Property>
</Object>

<!-- ptype for debugging, not necessary -->
```



Purpose

- 🐾 Simplify GObject-XML conversion
- 🐾 Allow developer per-property control
- 🐾 Follows json-glib's JSON serialization



API

```
interface Serializable : GLib.Object {  
    bool deserialize_property (string prop_name, ParamSpec spec,  
                                GXml.DomNode prop_node);  
    GXml.DomNode? serialize_property (string prop_name, ParamSpec spec,  
                                        GXml.Document doc);  
    /* to override GObjectClass behaviour, optional */  
    unowned ParamSpec? find_property (string property_name);  
    unowned ParamSpec[] list_properties ();  
    /* to override GObject behaviour, optional */  
    void get_property (ParamSpec spec, ref Value str_value);  
    void set_property (ParamSpec spec, Value value)  
}
```



Features

- GXmlSerialization class

 - Automatically converts a GObject into XML and vice versa

- GXmlSerializable interface

 - Developer controls concept of "properties", ability to serialize data other than properties.

 - Developer controls logic handling a property



Features

- Recursive (also a source of a potential problem)
- Automatically handles
 - Simple types (int, bool, double)
 - Enums
 - GXmlSerializable objects
 - Some collections
 - More as demanded

Easing obstacles

🐾 Autotools

🐾 GtkDoc + examples

🐾 Local VAPI (patches upstream)

🐾 GIT works right now on current distros

🐾 Lots of tests



Fin



Security with usability

Security without the poor design

Sam Bull

User design

- Design with the user in-mind.
- What's the easiest, most streamlined design?
- Can that design be met without losing security.

Protecting documents

- Encrypt folders of user's choice.
- Decrypt these folders transparently.

Design

- What's the most streamlined design to encrypt?
- What's the most streamlined design to decrypt?

Design

- What's the most streamlined design to encrypt?

Right-click folder, encrypt.

- What's the most streamlined design to decrypt?

Open folder, decrypted contents are displayed.

Summary

- Security shouldn't interfere with user experience!
- Working prototype available at:
<http://blog.sambull.org/easily-encrypt-folders-2>

Geocode-glib Library

<https://git.gnome.org/browse/geocode-glib/>

Satabdi Das

OPW Intern, Round 5

Mentored by Bastien Nocera



- Wrote Server and client libraries for GeolP geo-location service
- Wrote Server of the Wi-Fi based geo-location service



- An IP based query returns –

```
{"ip":"123.23.23.23","latitude":10.25,  
"longitude":105.96669769287109,  
"country_name":"Vietnam",  
"country_code":"VN",  
"region_name":"Phu Yen",  
"city":"Vinh Long",  
"accuracy":"city",  
"timezone":"Asia/Phnom_Penh",  
"attribution":"This product includes GeoLite data created by MaxMind, available  
from http://www.maxmind.com\n"}
```

- An Wi-Fi based query returns –

```
{"latitude":40.060449299999988,"longitude":-105.2094195,"accuracy":24}
```



Life After OPW

WFS-India

- Started Women in Free Software and Culture in India (<http://www.wfs-india.org/>)
- Organized an online localization workshop, an online workshop on Git.
- Planning to organize an online workshop on IRC

Joined a job

Plans to contribute more code to open-source projects



<https://techchicblog.wordpress.com/>

Responsive Design: Gnome website

Saumya Dwivedi

Outreach Program for Women
[June-Sept 2013]

Responsive Design: Gnome website

- Technique to make a website respond effectively to various device sizes and viewing environment.
- Use of CSS3 media queries.
- Minimize user scrolling and resizing.
- Why not a different website version for mobile?



- Responsive Web Design was coined by Ethan Marcotte in 2010.

Responsive Design: Gnome website

- Difficult to maintain a mobile version for every possible device size.
- Huge boost in mobile market!
- Responsive design makes a website consistent across devices using only a single style sheet.
- Makes the website easy to maintain, develop and deploy.



- 2013 is being dubbed as the year of responsive web design !!

Responsive Design: Gnome website

- OPW site is now responsive.
- Responsiveness in the main Gnome website is work in progress !

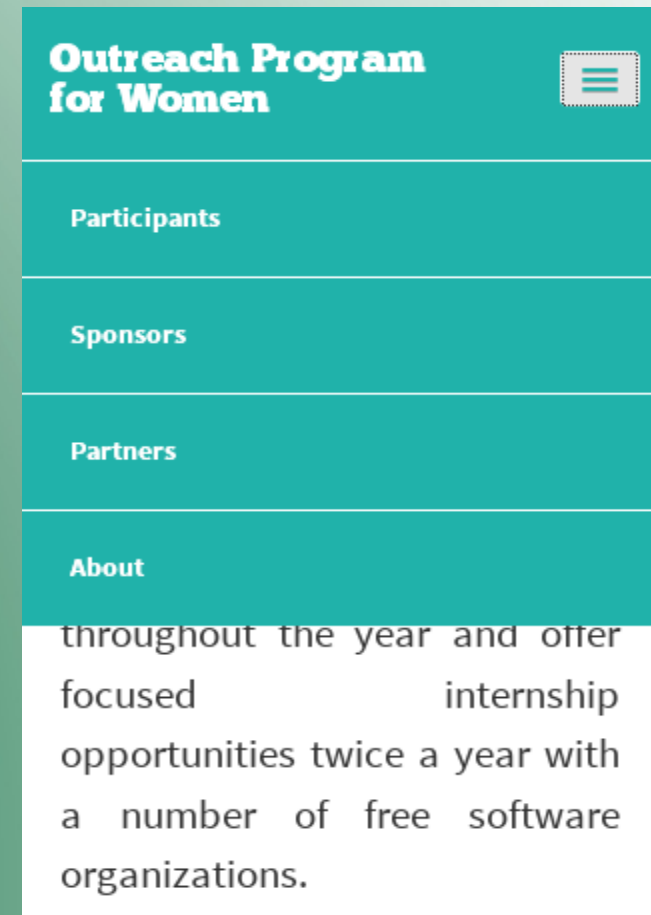

- Responsive web design is web design done right. -Andy Clark

Responsive Design: Gnome website

Outreach Program for Women Participants Sponsors Partners About

The Outreach Program for Women (OPW) helps women get involved in free and open source software. We provide a supportive community for beginning to contribute any time throughout the year and offer focused internship opportunities twice a year with a number of free software organizations.

[Learn how to get started and apply!](#)



Participants

Congratulations to the **37 participants** accepted for the June - September 2013 round of the Outreach Program for Women!

Women who are students applying to work on coding projects were encouraged to apply for Google Summer of Code as well. The administrators of both programs then coordinated to accept the top applicants for one of the programs. Congratulations to the **12 applicants** who applied for both the Outreach Program for Women and Google Summer of Code, and were accepted for Google Summer of Code!

Outreach Program for Women 

The Outreach Program for Women (OPW) helps women get involved in free and open source software. We provide a supportive community for beginning to contribute any time throughout the year and offer focused internship opportunities twice a year with a number of free software organizations.

Thank you!



GNOME Event website manager

by Saumya Pathak
a GNOME OPW Intern (Round 6)

Aim: Easy setup of GNOME conference websites.



Add new speaker

Enter title here

 Add Media

Visual

Text

b

i

link

b-quote

del

ins

img

ul

ol

li

code

more

lookup

close tags

fullscreen

Word count: 0

Details about the speaker

Links(enter seperated with ';')

Sessions(enter seperated with ';')

Speaker

image

Upload image of speaker if available

No image selected

Add Image

Customizable theme:

localhost/work/wp-admin/customize.php

Close Saved

wpbootstrap

Site Title & Tagline

Images

Color Scheme

Navigation bar Color

Select Color

Background Color

Select Color

Headings Color

Select Color

Font Color

Select Color

Links Color

Select Color

Navigation bar links color

Select Color

Static Front Page

Collapse

GNOME GUADEC

Call for papers Sample Page



Registration Open

Registrations for the conference are now open. You can register to attend the conference and make the payment online. To volunteer for the conference, read further instructions.

[Read more](#)

Hello world!

Sponsors

The logos of the sponsors can be put up here.



Work done so far:

- Gathering requirements of the system.
- Research on various backend systems.
- Basic theme design.
- Making the theme customizable.

The learning curve:

Technical:

- Wordpress
- Ruby
- Responsive CSS

About FOSS:

- Contributing to a project.
- Dealing with bugs.
- The wonderfulness of the Open source world!



GNOME



Shivani Poddar

(Eslam Mostafa, Sai)

GNOME-Music

OPW Intern

(GsoC Interns)



Gnome-Music!

Activities Music Thu 00:50

Albums Artists Songs Playlists

David Arnold, Michael Price

David Guetta

David Guetta ft Usher

Devi Sri Prasad

Dhanush

Dido

DoReGaMa

Dolla Feat.T-Pain And Akon

Drake

EgySeeD.CoM - Ashley Tisdale

Eldagalmk

Eli Young Band

Ellie Goulding

Elliott Smith

Dido

Life for Rent (2003)



- 1 White Flag
- 2 Stoned
- 3 Life for Rent
- 4 Mary's in India
- 5 See You When You're 40
- 6 Don't Leave Home
- 7 Who Makes You Feel
- 8 Sand in My Shoes
- 9 Do You Have a Little Time
- 10 This Land is Mine
- 11 See the Sun

Dido

No Angel (1999)



- 1 Here with Me
- 2 Hunter
- 3 Don't Think of Me
- 4 My Lover's Gone
- 5 All You Want
- 6 Thank You
- 7 Isobel
- 8 I'm No Angel
- 9 My Life
- 10 Take My Hand [*]

Dido

White Flag (2003)



- 1 White Flag
- 2 Paris
- 3 White Flag (Johnny Toobad Mix)

What we did so far..

- Fixed Bugs – design, logic, optimization bugs
- Cleaned up for Phase 1
- Implemented Selection view and Playlist view from Phase 2
- Started implementing search from Phase 3
- Refined our coding style, git usage, creating UI from glade.
- Intensive testing!

Few screen-shots for the above implemented functionalities..

Search!

Activities Music Mon 14:53

Albums Artists Songs Playlists

bo

Backstreet Boys

Bon Jovi

Boys Like Girls

19. Amelie

Soundtrack by Yann Tiersen (2001)



- 1 La Valse D`amelie (Version Pi
- 2 La Valse Des Monstres
- 3 Le Banquet
- 4 Sur Le Fil
- 5 La Redecouverte
- 6 Soir De Fate
- 7 Si Tu N`etais Pas Là (Frehel)
- 8 La Dispute
- 9 La Valse Des Vieux Os
- 10 La Valse D`amelie (Version Or
- 11 Pas Si Simple
- 12 Le Moulin
- 13 à Quai
- 14 Guilty
- 15 L`autre Valse D`amelie
- 16 La Noyee
- 17 Comptine D`un Autre Ete - L`a
- 18 La Valse D`amelie
- 19 Les Jours Tristes (Instrument
- 20 J`y Suis Jamais Alle

Load More

Selection..

Activities Music Mon 15:53

Click on items to select them

Cancel

1997-05-06 - Morning ... Studios Elliott Smith	50 First Dates UB40	A Beautiful Mind James Horner	Alice In Wonderland Danny Elfman	All or Nothing Christopher Lawre...	AM Gold 1975 Captain & Tennille	American Beauty Eldagalmk
American History X Eldagalmk	Assassin's Creed II Original ...undtrack Jesper Kyd	Assassin's Creed: Brotherh...undtrack Jesper Kyd	Babel Original Soundtrack Gustavo Santaola...	Babylon Skindred	Back on a Mission Cirrus	Bad Michael Jackson
Bare Bones Bryan Adams	Batman & Robin Movie Themes	Batman Returns movie themes	BGM Amrutha A R Rahman	bgm bhagat singh A R Rahman	BGM Boys A R Rahman	BGM Dil Se A R Rahman

Add to Playlist



Sindhu Sundar

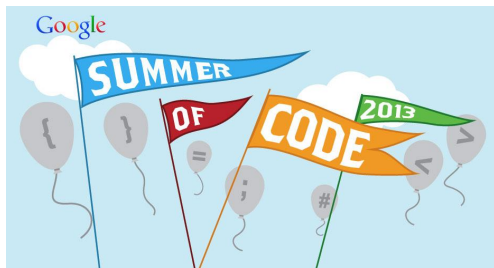

Gitg



**Terminal
Dictionary**



Terminal User Help



The image shows two side-by-side browser windows. The left window is titled 'GNOME Terminal Manual' and displays a table of contents with links to 'Introduction', 'Getting Started', 'Usage', and 'Preferences'. The right window is titled 'Terminal' and displays the 'Terminal Help' page, which is organized into sections: 'Introduction', 'Getting started', 'Working with text', and 'Customize appearance'. Each section contains sub-topics with brief descriptions.

Section	Sub-section	Description
Introduction	Introduction	What is <i>Terminal</i> ?
	Overview of a terminal	What is a terminal?
Getting started	Execute a command	Launch programs or run commands using <i>Terminal</i>
	Manage tabs	Add, remove and reorder <i>Terminal</i> tabs.
Working with text	Copy and paste	Copy and paste text in <i>Terminal</i> .
	Text selection	Specify which characters should be considered as part of a word.
	Hyperlinks and email addresses	Open links to web and email addresses.
	Use Find	Search the <i>Terminal</i> output.
Customize appearance	Save contents	Save <i>Terminal</i> output to a file.
	Change cursor	Select different cursor style
	Fullscreen session	Enable fullscreen mode
	Change font and style	Use system fonts or choose a custom font for your terminal.
	Terminal sizes	Change the <i>Terminal</i> window size
	Color schemes	
	Zoom in and zoom out	



Dictionary User Help



Dictionary Manual

Page View Go Bookmarks

Dictionary Manual

Dictionary Manual

Next ▶

- Introduction
- Getting Started
- Usage
- Preferences
- The Dictionary Applet

Next ▶

About

Dictionary

Page View Go Bookmarks

Dictionary

Dictionary Help

Introduction

What is *Dictionary*?

Features

Copy definition

Select and copy a definition to another application.

Keyboard shortcuts

You can use keyboard shortcuts to navigate around *Dictionary* more efficiently.

Look up a word or term

Find the definition of a word or term.

Print a definition

Print preview and print definitions.

Save a definition

Save a copy of a definition to a text file.

Search within a definition

Find text in a definition.

Select a different dictionary

Similar words

View related results in other dictionaries.



Gitg - Git Format Patch



The screenshot shows the Gitg application window. The title bar reads "gitg format-patch". The interface is divided into several sections:

- Left sidebar:** Contains navigation options: "All commits", "Branches" (with "format-patch" selected), "Remotes", "origin", and "Tags" (listing versions from v0.0.1 to v0.2.4).
- Commit list:** A list of commits with their subjects and authors. The top commit is "format-patch" by Sindhu S, 22 hours ago. Other commits include "files: better packing for paned", "Updated Polish translation", "Updated Greek translation", etc.
- Commit details:** Below the list, the selected commit "format-patch" is shown with the author "Sindhu S <sindhus@gnome.org>" and the message "Double click on any commit to create patch". A "Get Patch" button is visible.
- Code diff:** The bottom section shows a diff for the file "gitg/history/gitg-history.vala". The diff highlights changes between lines 152 and 154, showing the addition of a connection to "double_click_to_create_patch".

```
... @@ -152,6 +152,44 @@
152 152         d_commit_list_model.disconnect(d_insertsig);
153 153         d_insertsig = 0;
154 154     }
155 155     d_main.commit_list_view.row_activated.connect(double_click_to_create_patch);
156 156 }
157 157
158 158 private void double_click_to_create_patch(Gtk.TreePath path, Gtk.TreeViewColumn column)
159 159 {
160 160     Gitg.Commit commit_selected = d_commit_list_model.commit_from_path(path);
161 161
162 162     string commit_subject = commit_selected.get_subject();
163 163     commit_subject = commit_subject.replace(" ", "-");
164 164     string commit_message = commit_selected.get_message();
165 165     var file = File.new_for_path(commit_subject+".patch");
166 166     string commit_shal = commit_selected.get_id().to_string();
167 167     string commit_legacydate = "Mon Sep 17 00:00:00 2001";
168 168     string commit_author = commit_selected.get_author().get_name();
169 169     string commit_author_email = commit_selected.get_author().get_email();
```



Gitg - Interactive Rebase

Start Rebase

Select starting point for rebase

Select ending point for rebase

Rebase

Author	Commit Message	Date	Action
John Doe	Add functionality 1	3/3/2013	Pick
John Doe	Add functionality 2	3/4/2013	Pick
John Doe	Add functionality 3	3/5/2013	Squash
John Doe	Add functionality 4	3/6/2013	Pick
John Doe	Add functionality 5	3/7/2013	Edit

Diff View for Commit

T I F F A N Y Y A U

O U T R E A C H P R O G R A M F O R W O M E N

M A R K E T I N G I N T E R N



Improving Volunteer Capture

- On wiki (live.gnome.org)
- How to start contributing



GNOME VIDEO

PUTTING A FACE TO THE
GNOME PROJECT

F-Spot Faces Tool

- **GSoC student:** Valentín Barros
(*valentin@sanva.net*)
- **Mentor:** Stephen Shaw
- **Project:** Adding positional tags and face detection to F-Spot

Project Info.

- This is really a port from the same tool I've implemented in Shotwell in GSoC 2011 and 2012.
- This GSoC should bring to F-Spot the same amount of Faces functionality that is available at Shotwell.
- Porting from Vala to C# is really easy, but the harder part is to adapt all the event handler infrastructure from Shotwell to F-Spot's ways to handle things —they are pretty different.

Screenshot (Shotwell)

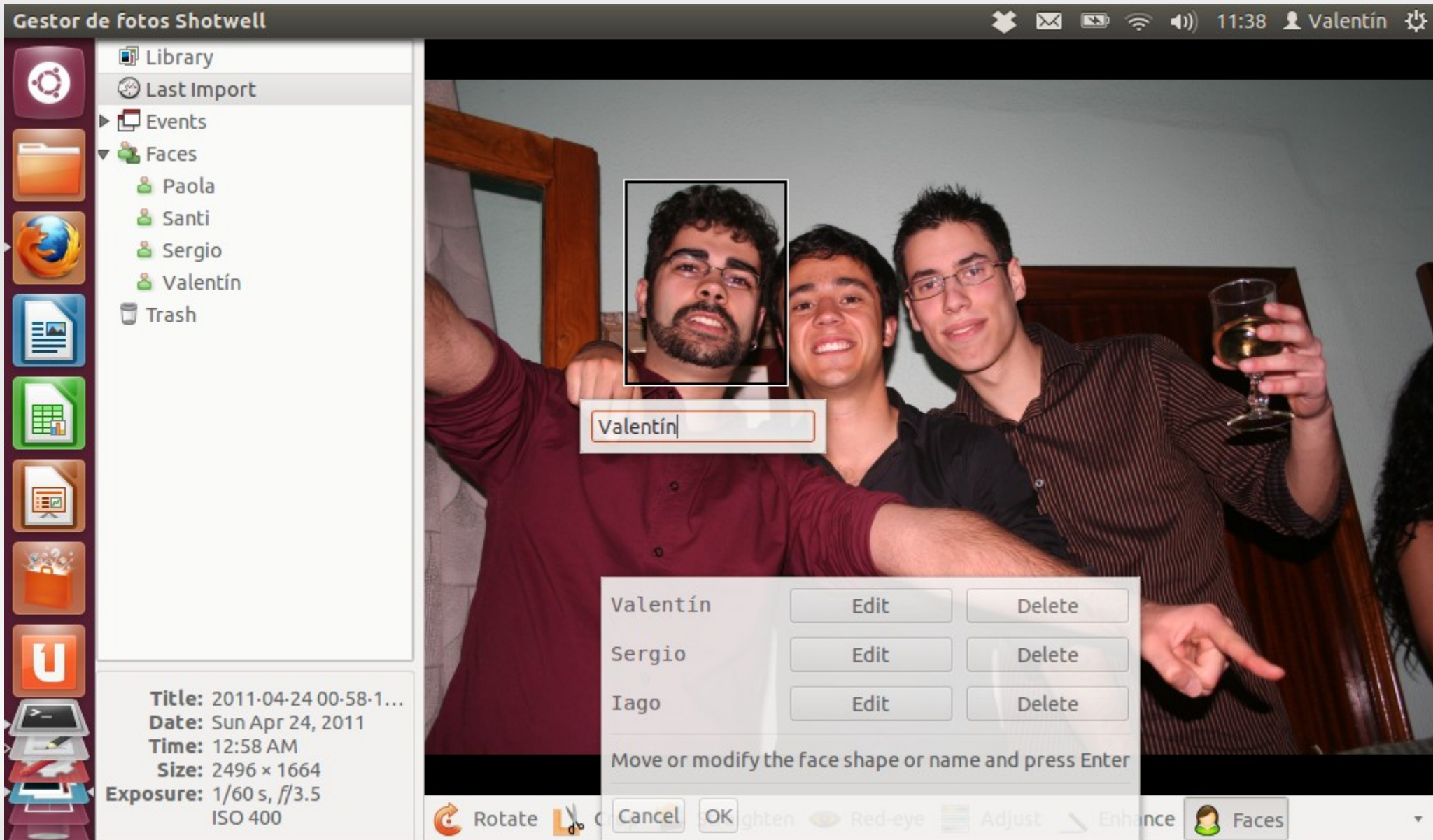

Screenshot (F-Spot)

F-Spot

Foto Editar Ver Buscar Etiquetas Herramientas Ayuda

+ Importar ↺ ↻ Examinar Editar imagen 30 de 82

Faces

Test message.

Test FacesTool

Histograma

Información de la imagen

Nombre 2011-04-24 00:58:18 - V...

Versión Original

Fecha 24/05/2011

Tamaño 24 MB

Exposición f/3.5

Longitud focal 22 mm

Cámara Canon

Crearor (D)

Tamaño del archivo 1,8 MB

Puntuación ☆☆☆☆☆

Valentín

Sergio

Iago

Editar Eliminar

Editar Eliminar

Editar Eliminar

Move or modify the face shape or name and press Enter

Detect faces Cancelar Aceptar

Descripción: ☆☆☆☆☆

82 fotos (1 seleccionada)

Current Status and Planning

- The tool works, but it is really really broken due to incompatibilities and code that isn't ported yet.
- I'm planning to fix critical errors and port the faces detection C++ programs integration this month.
- In September I should be able to clean up code and fix bugs to bring F-Spot face detection in an usable way.

Lua support for Grilo

Victor Toso (intern)
Juan Suárez (mentor)

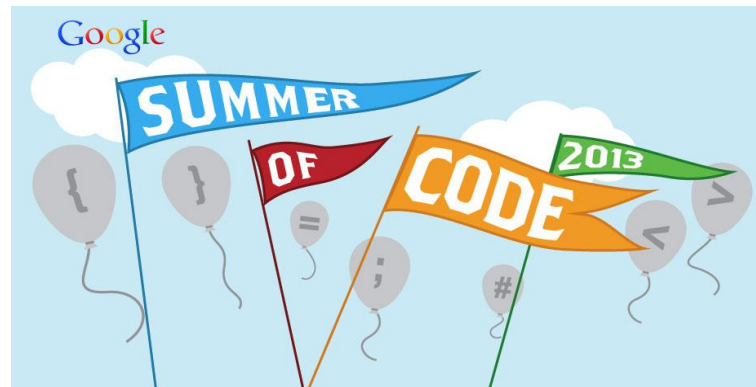

Goals

- New language to implement sources
- Making lua-sources transparent to Grilo
- Grilo library to lua
- Good documentation to help new developers

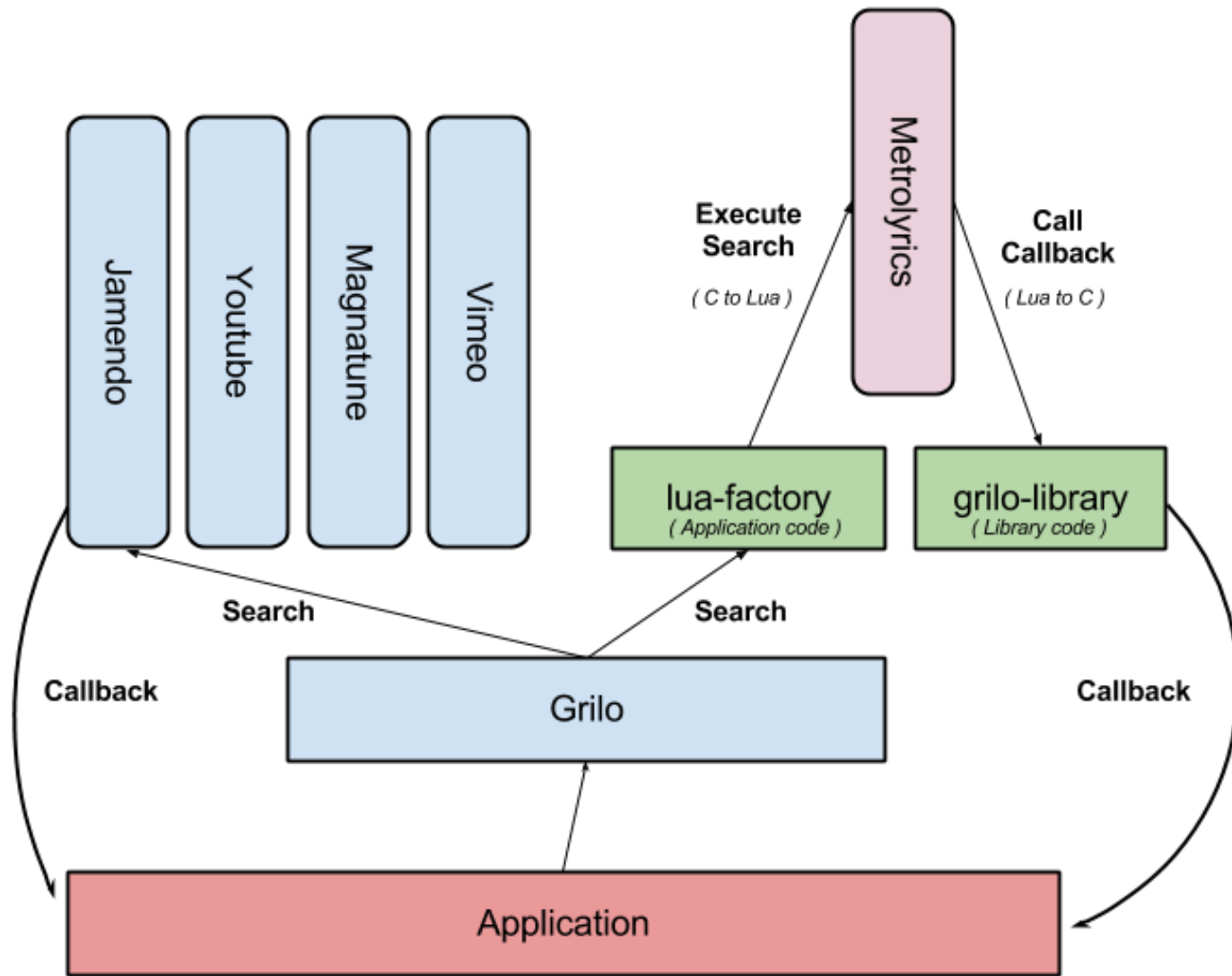

References

- www.lua.org/pil/
(Programming in Lua by Roberto Ierusalimschy)
- wiki.gnome.org/Grilo
(All about Grilo)
- victortoso.com
(My blog)